

# KDC-8090R

## SERVICE MANUAL

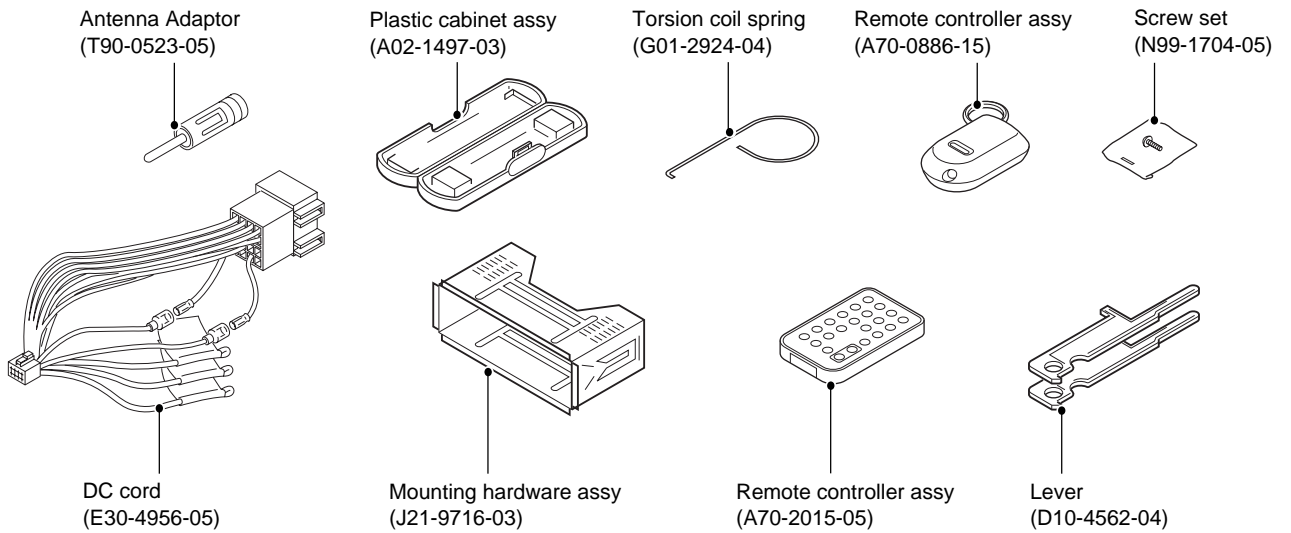
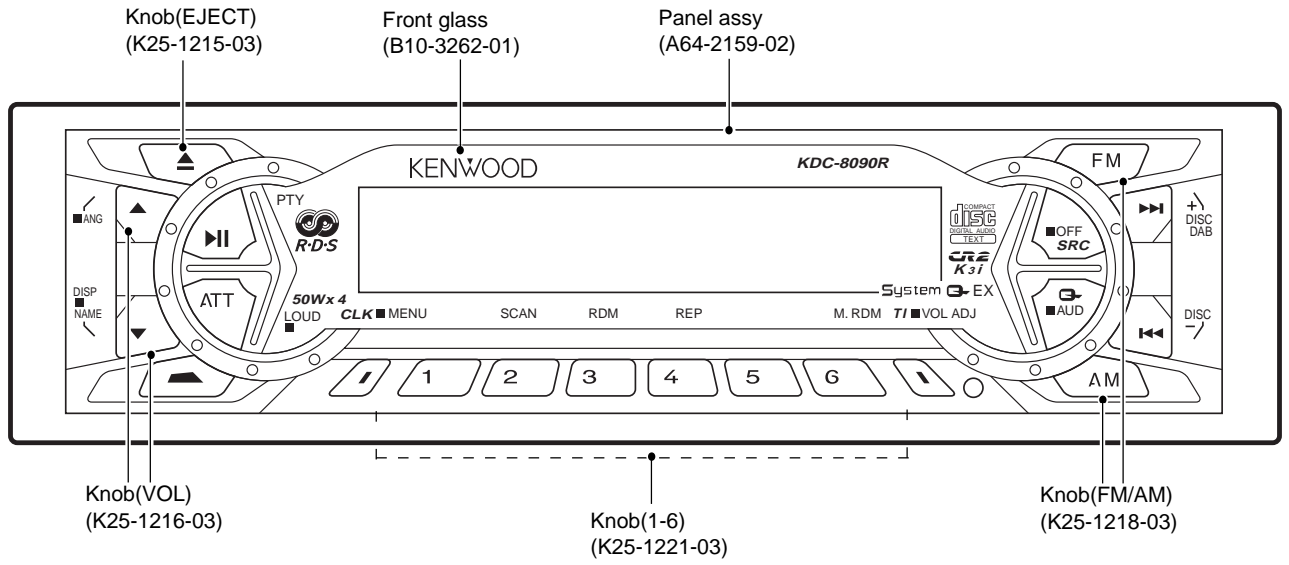

# KDC-8090R

## BLOCK DIAGRAM

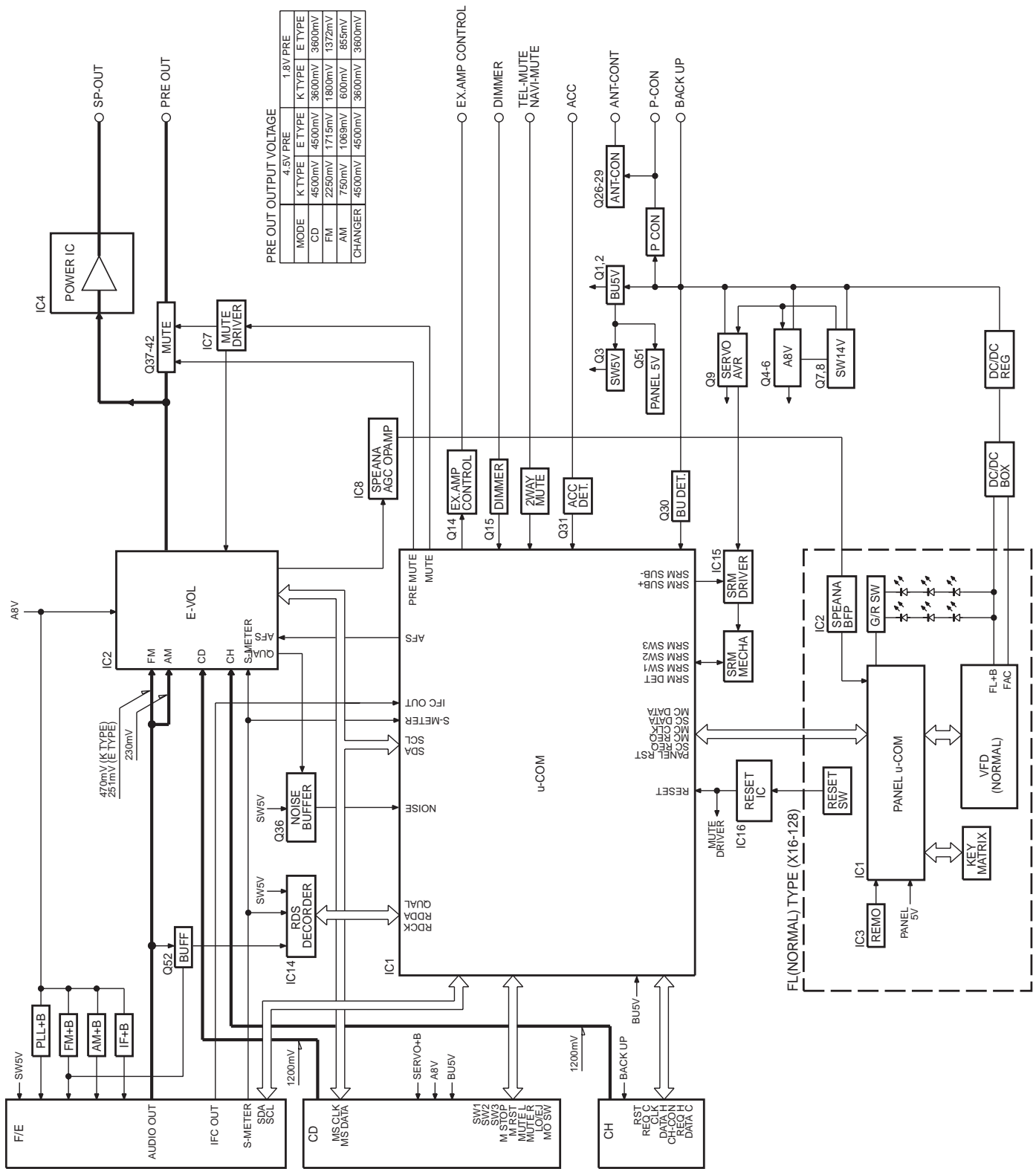

PRE OUT OUTPUT VOLTAGE

MODE	K TYPE	E TYPE	K TYPE	E TYPE
CD	4500mV	4500mV	3600mV	3600mV
FM	2250mV	1715mV	1800mV	1372mV
AM	750mV	1068mV	600mV	855mV
CHANGER	4500mV	4500mV	3600mV	3600mV

## MICROCOMPUTER'S TERMINAL DESCRIPTION

System  $\mu$ -com: UPD703033GC051

### ●Terminal description

Pin	Function	I/O	Description	Processing Operation
1	AM+B	O	AM power terminal	H: During AM radio operation
2	FM+B	O	FM power terminal	H: During FM radio operation H: During FM radio operation if with RDS, RBDS
3	AFS	O	Switching terminal for noise detection	L: During AF search, FM seek H: During receive
4	PLL-DATA	I/O	Data I/O terminal to F/E	
5	PLL-CLK	I/O	CLK terminal to F/E	
6	Evdd	-	Positive power terminal	
7	Evss	-	GND terminal	
8	N.C	O	Open (not used)	
9	BEEP	O	BEEP output terminal	
10	N.C	O	Open (not used)	
11	PRE-MUTE L	O		L (during CD): when M MUTE L is L (low) L during momentary power down Fixed at H only during 2 zone
12	PRE-MUTE R	O		L (during CD): when M MUTE R is L (low) L during momentary power down Fixed at H only during 2 zone
13	IC2-SDA	I/O	IC2, IC5, CD mechanism, DATA line	
14	IC2-SCL	O	IC2, IC5, CD mechanism, CLK line	
15	N.C	O	Open (not used)	
16	N.C	O	Open (not used)	
17	N.C	O	Open (not used)	
18	TEST	-	Test terminal	
19	P-MUTE	O	Power IC MUTE terminal	L: During Power-OFF L: During All-OFF L: During Tell-mute
20	P-STBY	O	Power IC STBY terminal	Power IC ON: H. Power IC OFF: L. During All-OFF: H
21	MUTE	O	MUTE terminal	ON: Open OFF: L
22	N.C	O	Open (not used)	
23	N.C	O	Open (not used)	
24	ACC-DET	I	ACC detection terminal	L: ACC H: No ACC
25	DIMMER	I	Small detection terminal	ON: L OFF: H
26	SW5V	O	5 volt power terminal	ON: L OFF: H
27	EXT-AMP-CO	O	External AMP control terminal (200ms)	L 40ms: Bus boost OFF L 70ms: Bus boost LOW L 100ms: Bus boost HI
28	P-CON	O	Power control terminal	Power ON: H Power OFF: L
29	ANT-CON	O	Antenna control terminal	TUNER, TI ON: H Open if no ANT-CON
30	P-ON	O	SW14V control terminal	Power ON: H Power OFF: L
31	RESET	I	Reset IN terminal	H: Normally H: During reset
32	XT1	I	Subclock terminal	Time count Operation during Power-OFF
33	XT2	-	Subclock terminal	
34	REGC	-	Capacitor output terminal for regulator inside microprocessor	
35	X2	-	Main clock terminal	Oscillates: During Power-ON Oscillates stop: During Power-OFF, during momentary power down
36	X1	I	Main clock terminal	
37	Vss	-	GND terminal	
38	Vdd	-	+B terminal	
39	CLKOUT	O	Internal system clock output	
40	N.C	O	Open (not used)	
41	N.C	O	Open (not used)	
42	TYPE0	I	Destination selector port	
43	TYPE1	I	Destination selector port	
44	TYPE2	I	Destination selector port	
45	N.C	O	Open (not used)	
46	IC2TYPE0	I	IC2 destination terminal	L: During default

# KDC-8090R

## MICROCOMPUTER'S TERMINAL DESCRIPTION

Pin	Function	I/O	Description	Processing Operation
47	IC2TYPE1	I	IC2 destination terminal	L: During default
48	CH-REQH	O	Request output to changer	
49	CH-RST	O	Reset output to changer	Normally L, after system RST reset is "H" for 400ms and then "L"
50	CH-MUTE	I	Mute request from changer	ON: H OFF: L
51	CH-CON	O	Changer control output	ON: H OFF: L
52	ILL-ON	O	FL, illumination output	ON: H OFF: L
53	M-MUTE L	I	Mute request from CD mechanism	ON: L
54	M-MUTE R	I	Mute request from CD mechanism	ON: L
55	BVdd	-	+B terminal	
56	BVss	-	GND terminal	
57	M-RST	O	Reset output to CD mechanism	Normally H, L: During reset Per mechanical control specs.
58	M-STOP	O	Stop request to CD mechanism	Stop: L H: During CD
59	N.C	O	Open (not used)	
60	LO/EJ	I/O	CD mechanism, LODING, EJECT selector	Stop, Brake: Hi-z, LOADING: L, EJECT: H
61	MOSW	O	CD mechanism, MOTOR, SW	LOADING, EJECT, Brake: H
62	N.C	O	Open (not used)	
63	CD-SW3	I	CD down SW detection terminal	Chucking: H
64	PAN-RESET	O	Reset output to panel microprocessor	Normally H, L: During reset, momentary power down
65	MC-REQ/PAN	I/O	REQ terminal/panel detection for panel microprocessor	L: During panel use
66	N.C	O	Open (not used)	
67	N.C	O	Open (not used)	
68	N.C	O	Open (not used)	
69	N.C	O	Open (not used)	
70	AVCONT	O	AD reference voltage control output	Same timing as P ON H: During operation
71	Avdd	-	+B terminal	
72	Avss	-	GND terminal	
73	Avref	I	Reference voltage supply terminal for A/D converter	
74	PHONE	I	PHONE detection terminal	Tel mute: Min 1 volt, Navi mute: Max.2.5 volt
75	SRM-SW3	I	Mask mechanism position detection input	See 01mask mechanical position detection chart
76	SRM-SW1	I	Mask mechanism position detection input	See 01mask mechanical position detection chart
77	SRM-SW2	I	Mask mechanism position detection input	See 01mask mechanical position detection chart
78	SRM-DET	I	Mask mechanism detection input	L: Mechanism H: No mechanism
79	NOISE	I	FM noise detection terminal	
80	S-METER	I	S meter detection terminal	
81	R-DATA	I	RDS DECODER DATA input terminal	Connect to GND: On models without RDS, RBDS
82	R-QUAL	I	RDS DECODER QUAL input terminal	Connect to GND: On models without RDS, RBDS
83	IFC-OUT	I	F/E IFC OUT input terminal	L: When station present
84	N.C	I	Open (not used)	Connect to GND
85	N.C	I	Open (not used)	Connect to GND
86	SRM-B	O	SRM mechanical submotor output terminal	
87	R-CLK	I	RDS DECODER CLK input terminal	Connect to GND: On models without RDS, RBDS
88	CH-REQC	I	Input request from changer	ON: L
89	SC-REQ	I	Communication request from panel microprocessor	
90	CD-SW1	I	LOADING SW detection terminal	LOADING start: L
91	CD-SW2	I	12cm disk detection switch terminal	12cm DISC: L
92	SRM+B	O	SRM mechanical submotor output terminal	
93	BU-DET	I	Momentary power down detection terminal	L: B.U H: No B.U (momentary power down)
94	CH-DATAC	I	Data input terminal from changer	
95	CH-DATAH	O	Data input terminal to changer	
96	CH-CLK	I/O	CLK I/O terminal used with changer	
97	SC-DATA	I	Data line from panel microprocessor	
98	MC-DATA	I/O	Data line to panel microprocessor	
99	MC-CLK	O	CLK terminal to panel microprocessor	
100	PAN5V	O	Panel 5 volt control terminal	L: Panel H: No panel

## ADJUSTMENT

### Test Mode

#### 1. How to enter test mode

While holding the FM key and the Preset 6 key, reset the unit.

#### 2. How to exit from test mode.

While holding down the Preset 6 key, reset the unit.

Note: Does not exit from test mode ACC-OFF, Power-OFF or Momentary power down

#### 3. Test mode reset status

- Sources are all OFF
- All display segment lit up
- Volume at -10dB (shows 30 on display)
- LOUD is OFF.
- CRSC is OFF regardless of whether switching function is provided.
- SYSTEM Q is in FLAT
- Blank skip is OFF. (C/R model)
- LEDs are white, no scanning. (VLCD model)

#### 4. Special displays in Tuner

When the following displays appear in tuner mode it shows a problem with the front end.

- "TNE2P NG" ..... F/E is not aligned and EEPROM is in reset (no settings) such as when shipped.
- "TNCON NG" .... Cannot communicate with F/E (front end).

#### 5. K3I switching

Each time the Preset 6 key is pressed in Tuner mode, switches one at a time through the following sequence: AUTO → Forced Wide → Forced Middle → Forced Narrow → AUTO. When reset, displays the following in AUTO.

- AUTO ..... FMA
- Forced Wide ..... FMW
- Forced Middle ... FMM
- Forced Narrow .. FMN

#### 6. CD receiver test mode specifications

- No automatic ejection during reset-start. Does not make a CD check in reset with a CD loaded.
- Using the Track up key jumps to the following tracks. No.9→No.15→No.10→No.11→No.12→No.13→No.14→and back to No. 9
- Using the Track down key moves 1 track downwards from the track being played.

#### 7. Audio items

- Momentarily pressing the Q key calls up audio adjustment mode.
- Pressing the \* key on the remote control calls up audio alignment mode.
- Continuous forward is disabled on the remote control.
- Bass/Middle/Treble are settable in 3 steps of MIN/CENTER/MAX with the Track up/down keys.

- Balance is settable in 3 steps of Left MAX/CENTER/Right MAX with the Track up/down keys.
- Fader is settable in 3 steps of Rear MAX/CENTER/Front MAX with the Track up/down keys.
- HPF is settable in 2 steps of THRU/220Hz with the Track up/down keys.
- LPF is settable in 2 steps of THRU/120Hz with the Track up/down keys.
- Bass f/Bass Q/Bass EXT/Middle f/Middle Q/Treble f do not appear in the audio alignment.

#### 8. Menu items

- Momentarily pressing the CLK key calls up the Menu mode.
- The DNPP/SBF keys on the remote control calls up Menu mode.
- Continuous forward is disabled on the remote control.
- Calendar adjust, calendar display switching and calendar memo are eliminated from forward (FL model)
- In color alignment mode, Preset 1 is red, 2 is blue, 3 is green and 4 is white. (VLCD model).
- Contrast is set in 3 steps of 0, 5, 10 and the reset value is 5. (VLCD/LCD models)
- Brightness adjustment is set in 3 steps of 0, 5, 10 and the reset value is 10. (Normal FL model)

#### 9. Backup current measurement

The MUTE terminal turns off 2 seconds (not 15 seconds) after being reset in ACC off (backup on). (The panel, CD and tape mechanisms are disabled during this time.)

#### 10. Special displays during All-Off with all lamps on

The following displays appear when the preset keys are pressed with all display segment lit up.

PRESET1	Version display (8 digits; Mo. Dy. Hr. Mn.) (Display) SYS XXXXXXXX system microprocessor PAN XXXXXXXX panel microprocessor
PRESET2	Serial No. display (8 digits) Note: CD/RK type eXcelon model (Display) SNo XXXXXXXX
PRESET3	Press once: Power-on time display (Does not count during All-Off) Press long: Clears the time display during power-on. (Display) PonTim XXXXX (C/R) MAX 65535(time)
PRESET4	Press once: TAPE/CD/MD operating time display. Press long: Clears TAPE/CD/MD operating time. (Display) CDTim XXXXX (CD/R) TapTim XXXXX (C/R) MAX 65535(time)
PRESET5	Press once: TAPE/CD/MD eject count display. Press long: Clears TAPE/CD/MD eject count display. (Display) EjeTim XXXXX MAX 65535(count)
PRESET6	Press once: PANEL open/shut count display. Press long: Clears PANEL open/shut count display. (Display) PnCt XXXXX MAX 65535(count)

## ADJUSTMENT

### 11. Others

- Automatic panel close is disabled when tape or CD is inserted. (M&T model)
- Panel operation is disabled at Power-ON or Power-OFF. (M&T model)
- Panel open and closes with the ATT key. (M&T model)
- No displays such as "CODE OFF" during Power-ON.
- Pressing the TI (AUTO) key during changer operation turns on 2zone. Cancel by pressing the TI (AUTO) key again. The P/S dot is lit during 2zone.
- Pressing the CLK key for 1 second or more during All OFF, calls up the Mask Key (security) write mode.

### Security items

#### • Forced power-ON mode (all models)

Even when writing is permitted by the security function (mask key), Power-on can be set for a 30 minute period each time the reset key is pressed while holding down the ATT key and Preset 4 keys. After 30 minutes elapses, can only be restored by using reset.

#### • How to register the security code for EEPROM (F/E) replacement (coded security models)

1. While holding the FM key and the preset 6 key, reset the unit.
  2. Call up security register mode by pressing the CLK key.
  3. Enter the code with the Preset 1/2/3/4 keys.  
For example, to enter the number, "3510"....
    - Press the Preset 1 key 4 times.
    - Press the Preset 2 key 6 times.
    - Press the Preset 3 key 2 times.
    - Press the Preset 4 key 1 time.
  4. Hold down the DISP key for at least 3 seconds and the message, "RE-ENTER" appears, so once again enter the code according to Step 3 above.
  5. Hold down the DISP key for at least 3 seconds, and the message, "APPROVED" appears.
  6. Cancel test mode. (See, 2. How to cancel the test mode.)
- Note: All clear cannot be performed on the security code for this model.

#### • Simple way to clear the security code (K type only)

1. During code request mode, press the VOL UP key for at least 3 seconds while holding down the DISP key.  
(---- will disappear)
2. Enter, "KCAR" with the remote controller as described below. (Same as on 00 model.)  
Press the remote controller 5 key twice, and press the Track Up key. (Enters a "K")  
Press the remote controller 2 key three times, and press the Track Up key. (Enters a "C")  
Press the remote controller 2 key once, and press the Track Up key. (Enters an "A")

Press the remote controller 7 key twice, and press the Track Up key. (Enters an "R")

3. Security function is canceled and unit sets to All-Off mode.
4. Code request mode appears if a mistake was made in entering the numbers.

#### • Mask key write method on initialized EEPROM

1. While holding the FM key and the preset 6 key, reset the unit.
2. Press the CLK key to call up mouse key register mode. The message, "TRANSMIT 1" appears. The display at this time shows "< >" rather than "[ ]".
3. Face the mask key towards the photosensor and hold down for half a second or longer.
4. When "TRANSMIT 2" appears, again hold down the mask key for at least half a second. The first and second counter codes are not compared at this time.
5. When the message, "APPROVED" appears, the writing is complete. The demo mode is set at this time and test mode is canceled.

Note: Just as with the previous model, if 30 minutes elapses and the code is not written, then an error is issued and power-OFF is triggered.

#### • How to initialize the mask key (Return to factory settings from mask key write permit status.)

1. While holding the FM key and the preset 6 key, reset the unit.
2. The message, "TRANSMIT 1" appears and mask key request mode is called up. The display at this time shows "\* \*" rather than "[ ]".
3. Cancel the mask key on the remote control by holding down for at least 3 seconds.
4. When "TRANSMIT 2" appears, again hold down the mask key for at least 3 seconds.
5. When the message, "APPROVED" appears, the mask key is canceled, demo mode is set, test mode is canceled, and the factory settings restored.

#### • How to All-Clear the mask key

1. While holding the FM key and the preset 6 key, reset the unit.
2. Press the CLK key to call up mouse key register mode. The message, "TRANSMIT 1" appears.
3. Face the mask cancel key towards the photosensor and hold down for 3 seconds or longer (until level reaches full).
4. When "TRANSMIT 2" appears, again hold down the mask key for at least 3 seconds. If "TRANSMIT 1" appears at this time, then redo the procedure, starting from step 3.
5. When the message, "APPROVED" appears, all-clear has been performed on the security data and operation returns to the Mask key write method on initialized EEPROM.



# PC BOARD (Component Side View)

## ELECTRIC UNIT

ELECTRIC UNIT  
(X25-8742-72)

Ref. NO.	IC	Q	Address
1			3N
2			4L
3			5O
4			6L
5			4M
6			3O
7			4N
8			4M
10			5N
11			4N
12			4N
14			3L
15			2L
16			3O
1			5P
2			4O
3			3N
4			4P
5			5P
6			5P
7			5O
8			5O
9			2L
10			2O
11			2O
12			2O
13			2O
14			4N
15			5O
16			4O
17			4O
18			3O
19			3O
20			3O
21			3O
22			3O
23			3O
24			5O
25			5O
26			5N
27			5M
28			5M
29			5N
30			4O
31			5O
32			4M
33			4N
34			3L
35			4L
36			4L
37			5N
38			5N
39			4N
40			4N
41			4N
42			4N
43			5L
44			5L
45			4L
46			4L
51			3L
52			3K

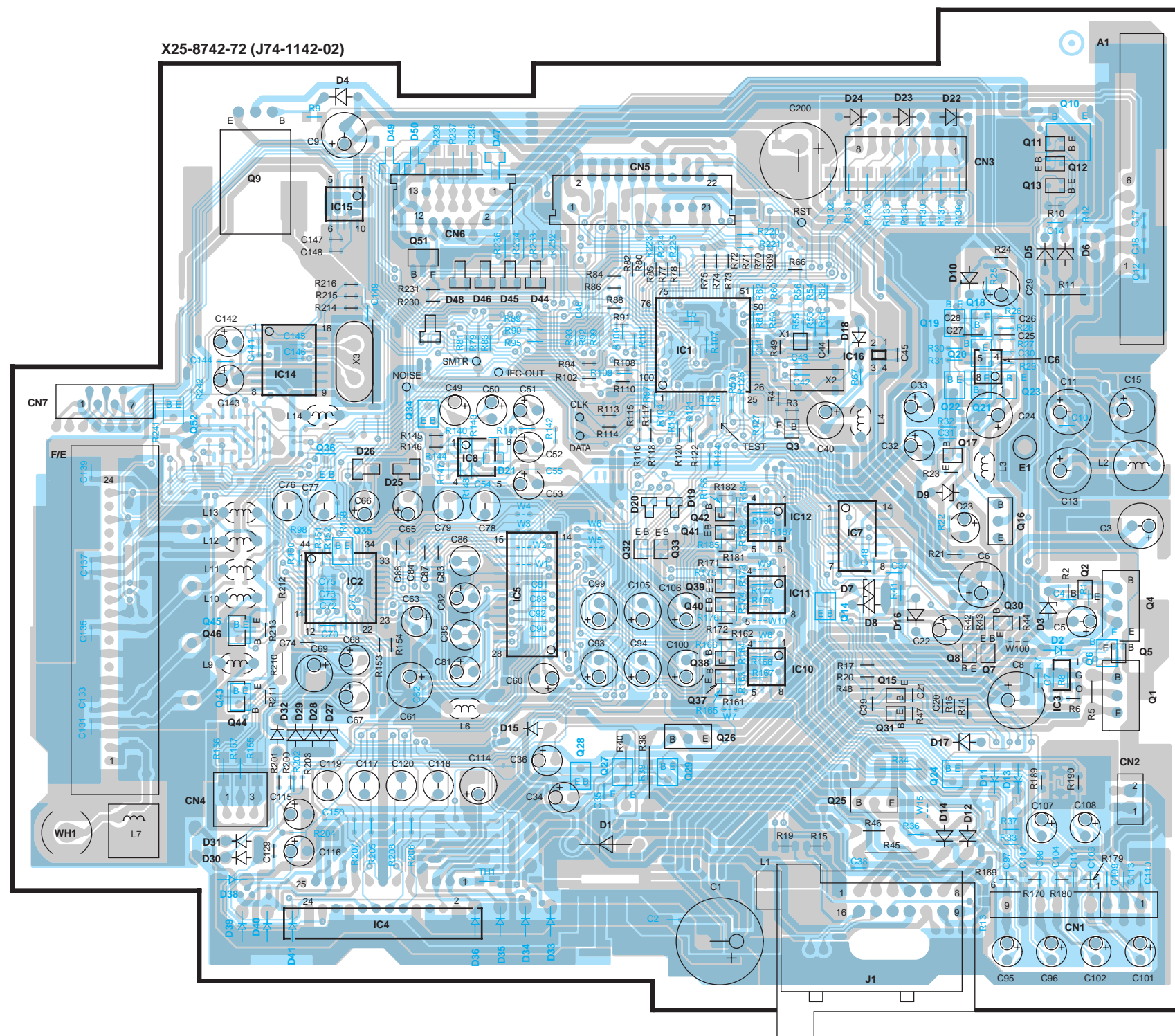

## SWITCH UNIT

X16-1282-70 (J74-1135-02)

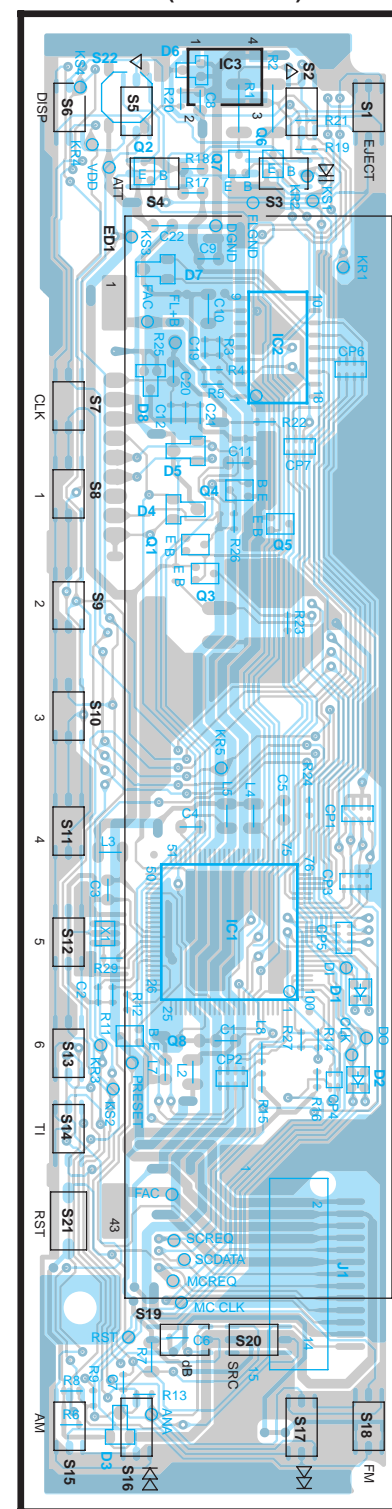

SWITCH UNIT  
(X16-1282-70)

Ref. NO.	IC	Q	Address
1			4Q
2			3Q
3			2Q
1			3Q
2			2Q
3			3Q
4			3Q
5			3Q
6			2Q
7			2Q
8			5Q

Refer to the schematic diagram for the values of resistors and capacitors.



# PC BOARD (Foil Side View)

## SWITCH UNIT

X16-1282-70 (J74-1135-02)

SWITCH UNIT  
(X16-1282-70)

Ref. NO.	IC	Q	Address
1			4T
2			3T
3			2T
1			3T
2			2T
3			3T
4			3T
5			3T
6			2T
7			2T
8			5T

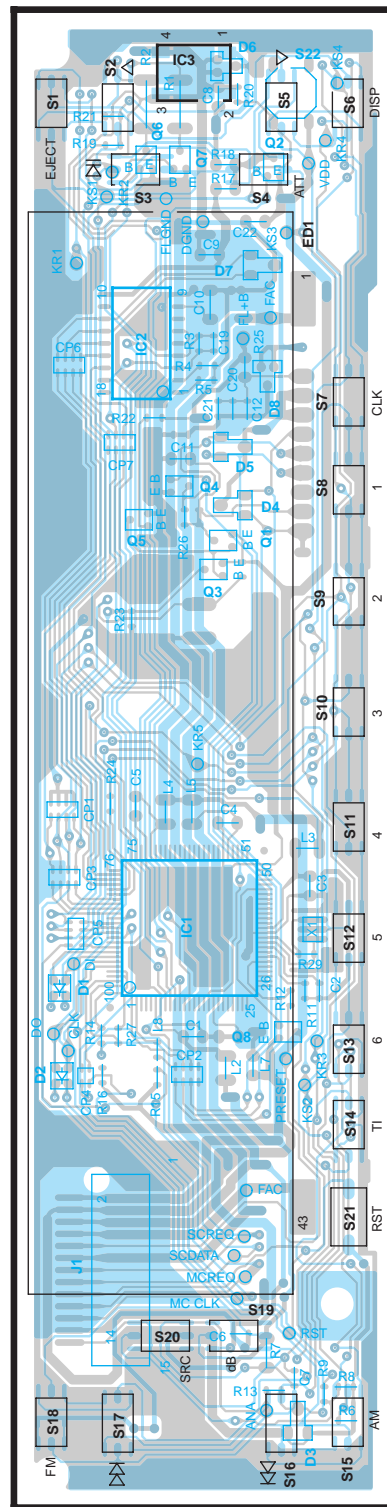

## ELECTRIC UNIT

X25-8742-72 (J74-1142-02)

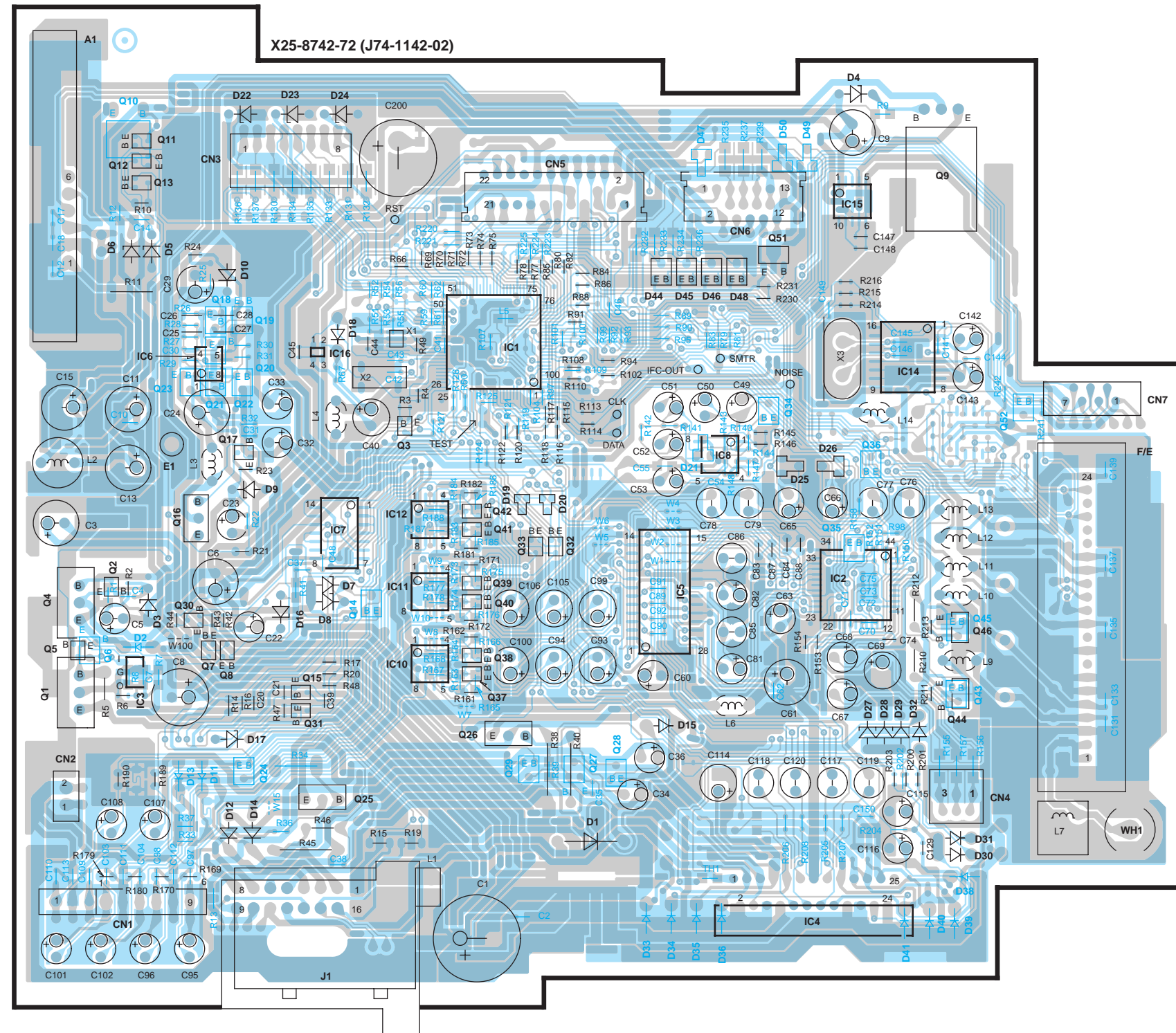

ELECTRIC UNIT  
(X25-8742-72)

Ref. NO.	IC	Q	Address
1			3W
2			4Y
3			5V
4			6Y
5			4X
6			3V
7			4W
8			4X
10			5W
11			4W
12			4W
14			3Y
15			2Y
16			3V
1			5U
2			4V
3			3W
4			4U
5			5U
6			5U
7			5V
8			5V
9			2Y
10			2V
11			2V
12			2V
13			2V
14			4W
15			5V
16			4V
17			4V
18			3V
19			3V
20			3V
21			3V
22			3V
23			3V
24			5V
25			5V
26			5W
27			5X
28			5X
29			5W
30			4V
31			5V
32			4X
33			4W
34			3Y
35			4Y
36			4Y
37			5W
38			5W
39			4W
40			4W
41			4W
42			4W
43			5Y
44			5Y
45			4Y
46			4Y
51			3Y
52			3Z

Refer to the schematic diagram for the values of resistors and capacitors.

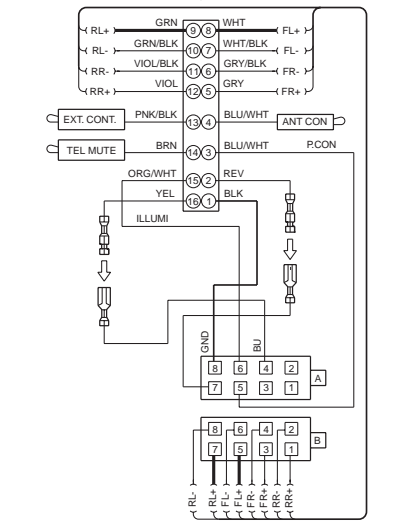
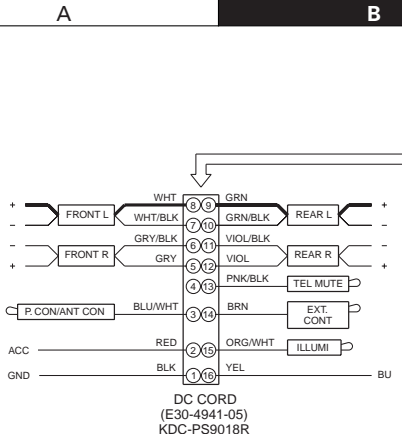

MODEL NAME	UNIT No.	(A)	(B)	(C)	(E)	F/E	A1
KDC-PS9018R	30-21	YES	YES	YES	NO	X86-3242-70	W02-3271
KDC-PS9590R	42-70	YES	YES	YES	NO	X86-3342-71	W02-3271
KDC-9090R	42-71	YES	YES	NO	NO	X86-3342-71	W02-3271
KDC-8090R	42-72	NO	NO	NO	YES	X86-3342-71	W02-3272

MODEL NAME	C1	C78, 79	C93,94, 99,100	C97,98, 103,104	C109, 110,113	CN1
KDC-PS9018R	C90-5377	YES	YES	YES	YES	E40-5066
KDC-PS9590R	C90-5377	YES	YES	YES	YES	E40-5066
KDC-9090R	C90-2822	YES	YES	YES	NO	E40-3241
KDC-8090R	C90-2822	NO	NO	NO	NO	E40-3241

MODEL NAME	D11, 12	D13	IC6	IC10, 11	R33	R51	R52	R53	R54
KDC-PS9018R	NO	YES	TC7662BEQA	YES	NO	YES	NO	YES	NO
KDC-PS9590R	NO	YES	TC7662BEQA	YES	YES	NO	YES	YES	NO
KDC-9090R	YES	NO	IC17665B8A	YES	YES	NO	YES	NO	YES
KDC-8090R	YES	NO	NO	NO	YES	YES	NO	YES	NO

MODEL NAME	R55	R56	R163,164, 173,174	R165-168, 175-178	W1-4	W5, 6	W7-10	W15
KDC-PS9018R	NO	YES	2.2K	YES	NO	NO	NO	NO
KDC-PS9590R	NO	YES	2.2K	YES	NO	NO	NO	YES
KDC-9090R	YES	NO	2.2K	YES	NO	YES	NO	YES
KDC-8090R	YES	NO	2.2K	NO	YES	YES	YES	YES

MODEL NAME	MASK u-COM ONLY				FLASH u-COM ONLY			
	C200	D2	IC16	W100	C200	D2	IC16	W100
KDC-PS9018R	NO	YES	S-80837ANNP	NO	YES	NO	S-80842ANNP	YES
KDC-PS9590R	NO	YES	S-80837ANNP	NO	YES	NO	S-80842ANNP	YES
KDC-9090R	NO	YES	S-80837ANNP	NO	YES	NO	S-80842ANNP	YES
KDC-8090R	NO	YES	S-80837ANNP	NO	YES	NO	S-80842ANNP	YES

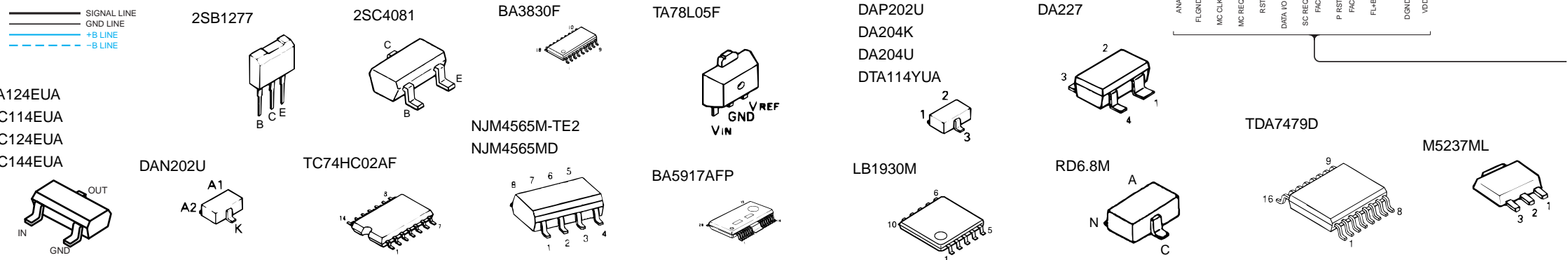
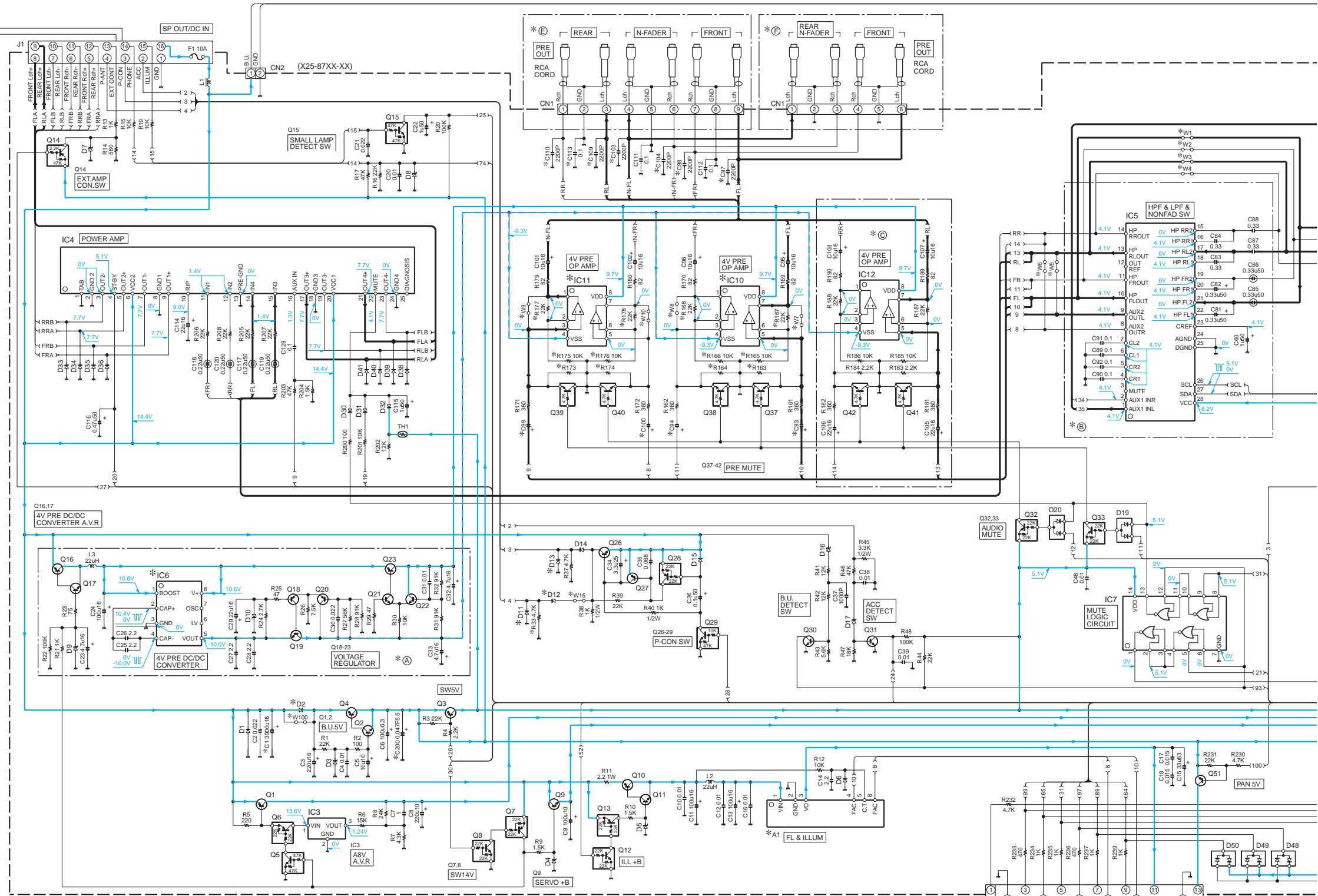
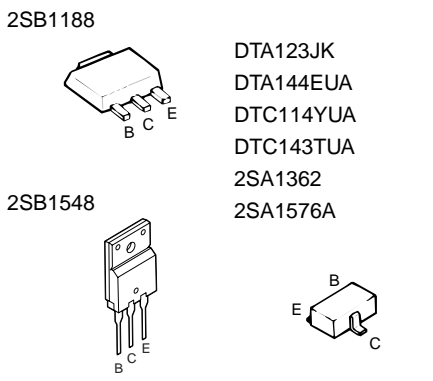

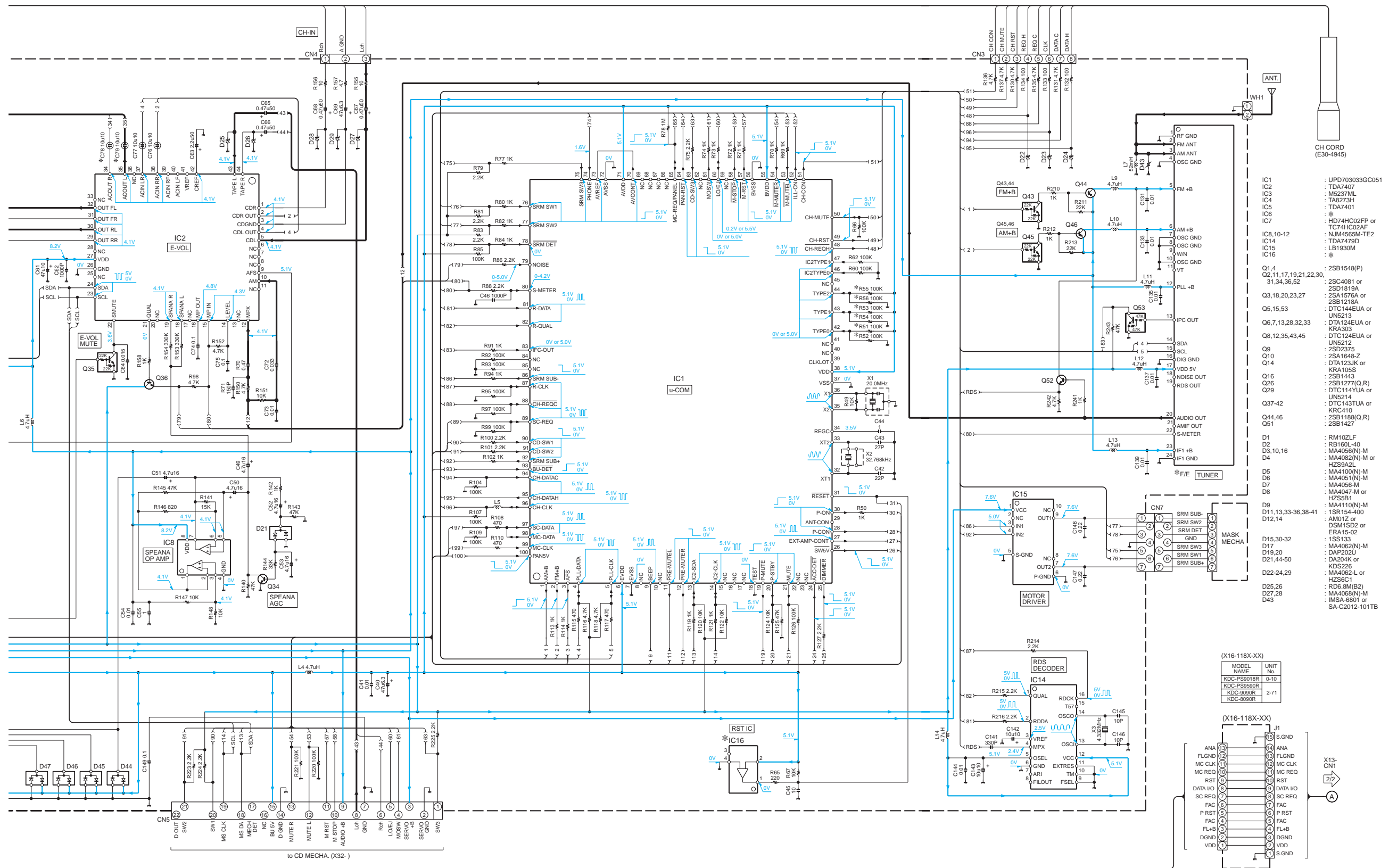

- IC1 : UPD703033GC051
  - IC2 : TA7407
  - IC3 : MS237ML
  - IC4 : TA8273H
  - IC5 : TDA7401
  - IC6 : \*
  - IC7 : HD74HC02FP or TC74HC02AF
  - IC8,10-12 : NJM4565M-TE2
  - IC14 : TDA7479D
  - IC15 : LB1930M
  - IC16 : \*
- Q1,4 : 2SB154B(P)
  - Q2,11,17,19,21,22,30,31,34,36,52 : 2SC4081 or 2SD1819A
  - Q3,18,20,23,27 : 2SA1576A or 2SB1218A
  - Q5,15,53 : DTC144EUA or UN5213
  - Q6,7,13,28,32,33 : DTA124EUA or KRA303
  - Q8,12,35,43,45 : DTC124EUA or KRA105S
  - Q9 : 2S1443
  - Q10 : 2SA1648-Z
  - Q14 : DTA123JK or UN5214
  - Q16 : DTC114YUA or UN5214
  - Q26 : 2SB1277(Q,R)
  - Q29 : DTC1143TUA or KR410
  - Q37-42 : 2SB1188(Q,R)
  - Q44,46 : 2SB1427
  - Q51 : 2SB1427
- D1 : RM10ZLF
  - D2 : RB160L-40
  - D3,10,16 : MA4056(N)-M or MA4082(N)-M
  - D4 : HZS9A2L
  - D5 : MA100(N)-M
  - D6 : MA4051(N)-M
  - D7 : MA4056-M
  - D8 : MA4047-M or HZS551
  - D9 : MA410(N)-M
  - D11,13,36,38-41 : 1SR154-400
  - D12,14 : AM012 or DSM1SD2 or ERA15-02
  - D15,30-32 : 1SS133
  - D17 : MA4062(N)-M
  - D19,20 : DAP202U
  - D21,44-50 : DA204K or KDS226
  - D22-24,29 : MA4062- or HZS6C1
  - D25,26 : RD6.8M(B2)
  - D27,28 : MA4068(N)-M
  - D43 : IMSA-6801 or SA-C2012-101TB

MODEL	UNIT No.
KDC-PS9018R	6-10
KDC-PS9590R	6-10
KDC-9090R	2-71
KDC-8090R	

MODEL	UNIT No.
KDC-PS9018R	6-10
KDC-PS9590R	6-10
KDC-9090R	2-71
KDC-8090R	

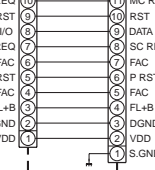

**CAUTION:** For continued safety, replace safety critical components only with manufacturer's recommended parts (refer to parts list). Indicates safety critical components. To reduce the risk of electric shock, leakage-current or resistance measurements shall be carried out (exposed parts are acceptably insulated from the supply circuit) before the appliance is returned to the customer.

DC voltages are as measured with a high impedance voltmeter. Values may vary slightly due to variations between individual instruments or/and units.

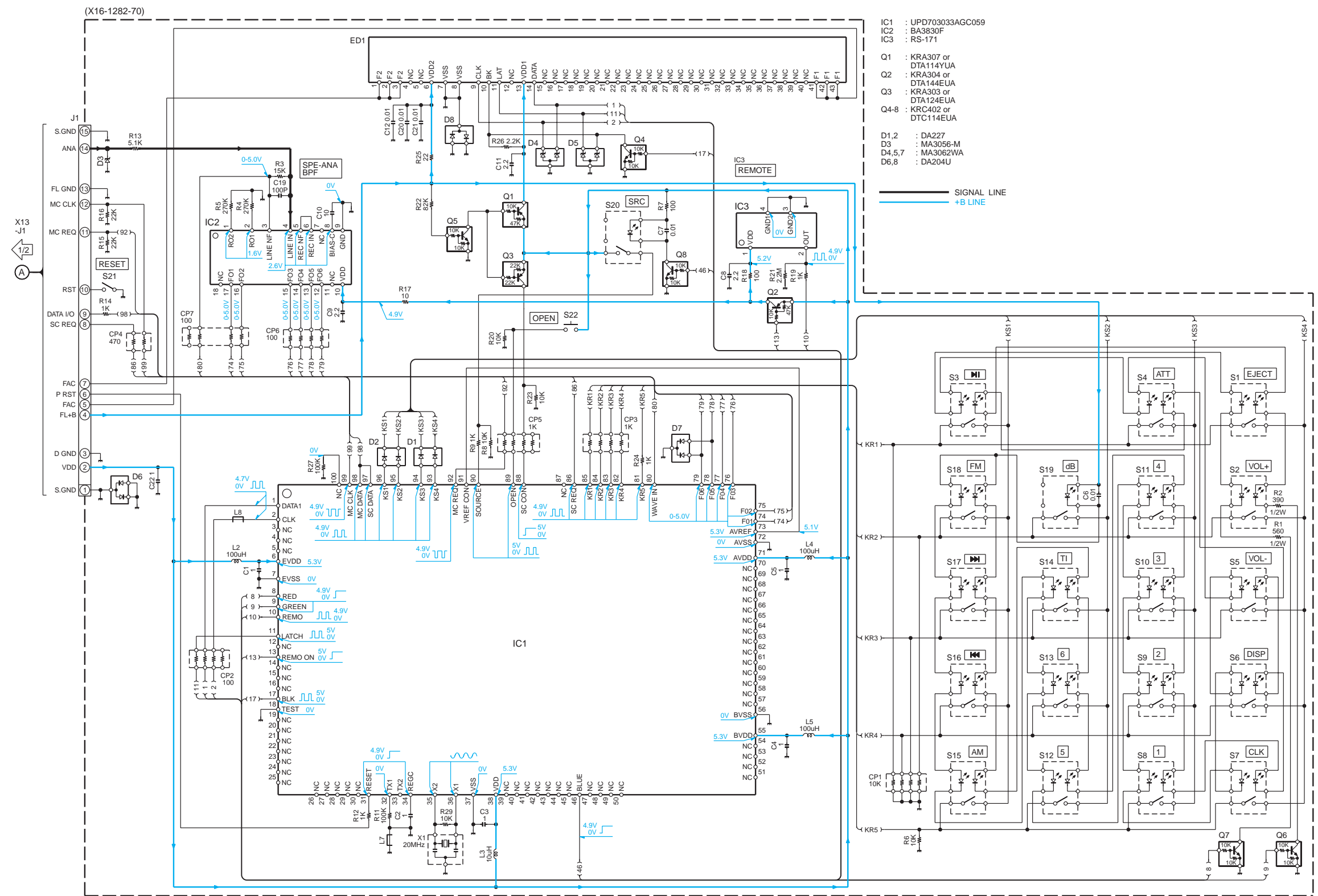

**CAUTION:**For continued safety, replace safety critical components only with manufacturer's recommended parts (refer to, parts list). ⚠ Indicates safety critical components. To reduce the risk of electric shock, leakage-current or resistance measurements shall be carried out (exposed parts are acceptably insulated from the supply circuit) before the appliance is returned to the customer.

DC voltages are as measured with a high impedance voltmeter. Values may vary slightly due to variations between individual instruments or/and units.

(X32-5030-00)

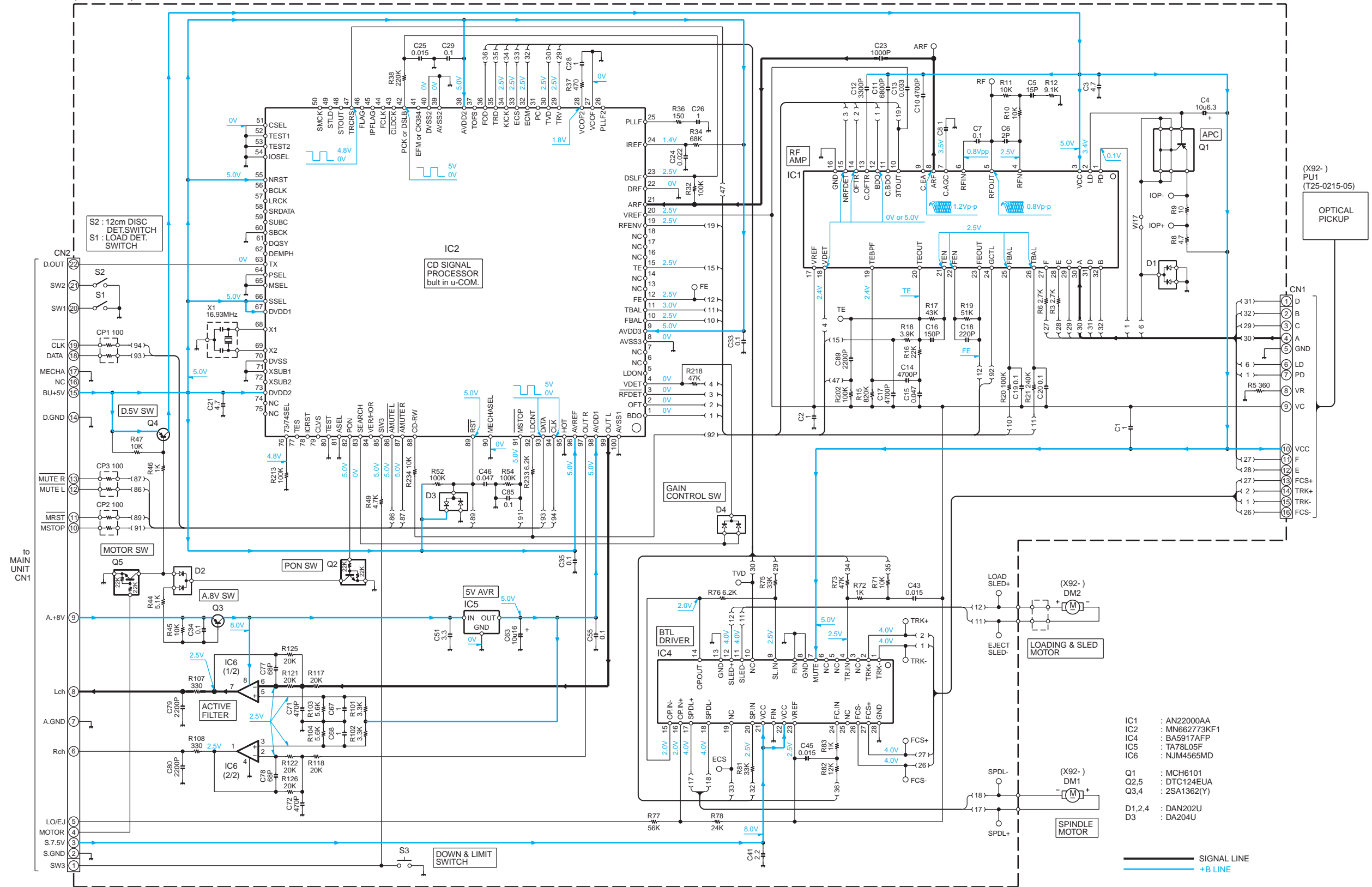

- IC1 : AN22000AA
- IC2 : MN662773KF1
- IC3 : BA5917AFP
- IC4 : TA78L05F
- IC5 : NJM4565MD
- Q1 : MCH6101
- Q2,5 : DTC124EUA
- Q3,4 : 2SA1362(Y)
- D1,2,4 : DAN202U
- D3 : DA204U

— SIGNAL LINE  
 — +B LINE

**CAUTION:** For continued safety, replace safety critical components only with manufacturer's recommended parts (refer to parts list). ⚠ Indicates safety critical components. To reduce the risk of electric shock, leakage-current or resistance measurements shall be carried out (exposed parts are acceptably insulated from the supply circuit) before the appliance is returned to the customer.

DC voltages are as measured with a high impedance voltmeter. Values may vary slightly due to variations between individual instruments or/and units.

CD MECHANISM

**KDC-8090R**  
**KENWOOD**

# KDC-8090R

## EXPLODED VIEW (CD MECHANISM)

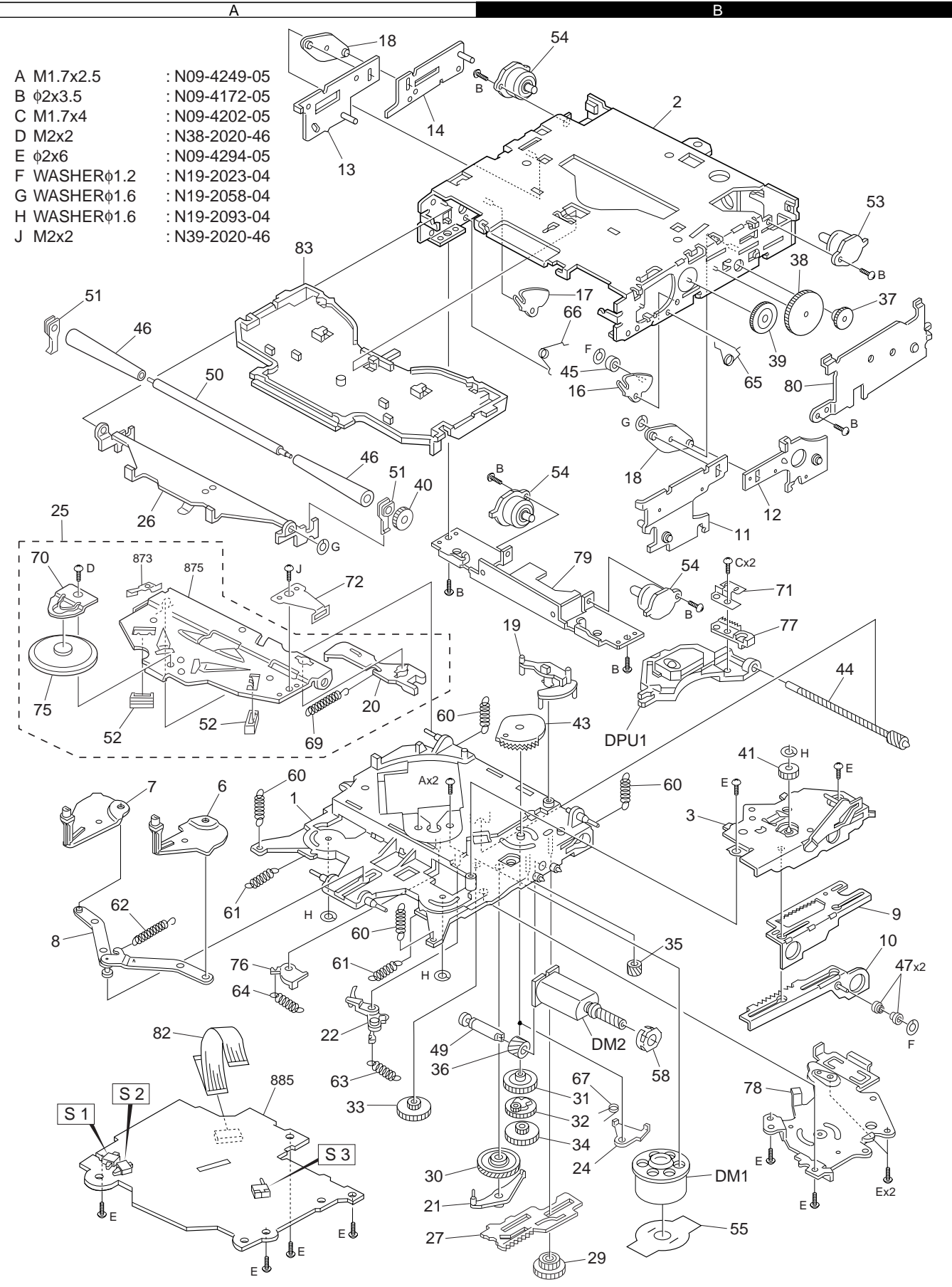

Parts with exploded numbers larger than 700 are not supplied.

# KDC-8090R

## EXPLODED VIEW (UNIT)

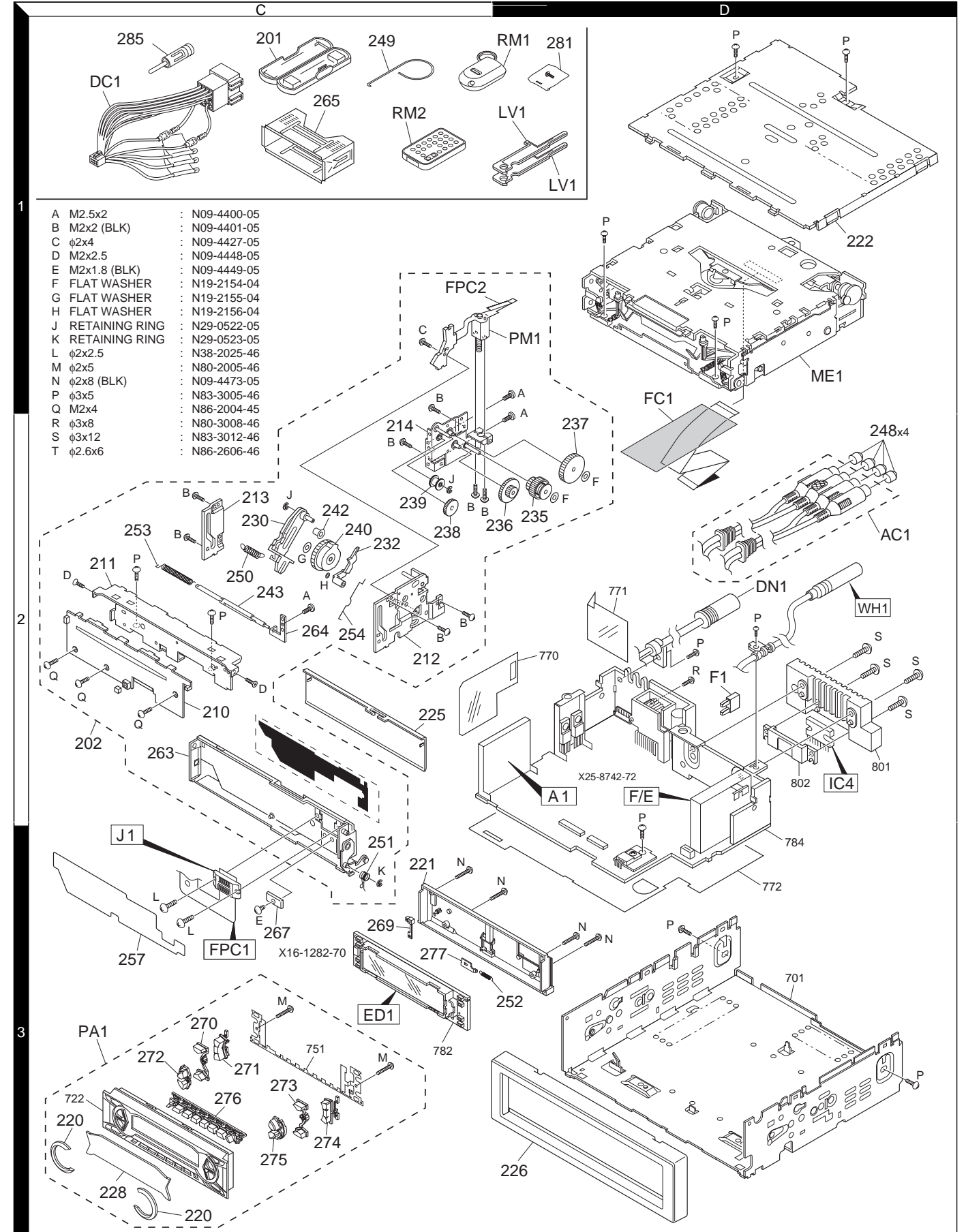

Parts with exploded numbers larger than 700 are not supplied.

## PARTS LIST

\* New Parts

Parts without Parts No. are not supplied.

Les articles non mentionnes dans le Parts No. ne sont pas fournis.

Teile ohne Parts No. werden nicht geliefert.

KDC-8090R

SUB CIRCUIT UNIT(X16-1182-71)

SWITCH UNIT(X16-1282-70)

Ref.No.	A d d	N e w	Parts No.	Description	Dest inati on
<b>KDC-8090R</b>					
201	1C		A02-1497-03	PLASTIC CABINET ASSY	
202	2C		A10-4803-02	CHASSIS ASSY	
210	2C		A22-2865-03	SUB PANEL ASSY	
211	2C		A10-4805-02	CHASSIS	
212	2C		A10-4807-03	CHASSIS CALKING ASSY	
213	2C		A10-4812-03	CHASSIS	
214	2C		A10-4810-03	CHASSIS CALKING ASSY	
220	3C		A21-4069-03	DRESSING PANEL	
221	3C		A46-1690-01	REAR COVER	
222	1D		A52-0779-02	TOP PLATE	
PA1	3C	*	A64-2159-02	PANEL ASSY	
RM1	1C		A70-0886-15	REMOTE CONTROLLER ASSY	
RM2	1C		A70-2015-05	REMOTE CONTROLLER ASSY	
225	2C		B03-3073-02	DRESSING PLATE	
226	3D		B07-3007-03	ESCUTCHEON ASSY	
228	3C	*	B10-3262-01	FRONT GLASS	
-			B46-0100-50	WARRANTY CARD	
-			B46-0632-04	ID CARD	
-			B58-1309-04	CAUTION CARD	
-			B64-1899-00	INSTRUCTION MANUAL E	
-			B64-1900-00	INSTRUCTION MANUAL F,G,D	
-			B64-1901-00	INSTRUCTION MANUAL I,S,P	
230	2C		D10-4563-04	ARM ASSY	
232	2C		D10-4590-04	ARM	
235	2D		D13-2135-04	GEAR ASSY	
236	2D		D13-2138-04	GEAR	
237	2D		D13-2139-04	GEAR	
238	2C		D13-2140-04	GEAR	
239	2C		D13-2141-04	GEAR ASSY	
240	2C		D13-2165-03	GEAR ASSY	
242	2C		D14-0754-04	ROLLER	
243	2C		D14-0760-03	ROLLER	
LV1	1D		D10-4562-04	LEVER	
AC1	2D		E30-4935-05	CORD WITH PINPLUG	
DC1	1C		E30-4956-05	DC CORD	
DN1	2D		E30-4945-05	CORD WITH DIN CONNECTOR	
FC1	2D		E39-0375-05	FLAT CABLE	
248	2D		F29-0049-05	INSULATING COVER	
F1	2D		F52-0006-05	FUSE(MINI BLADE TYPE)	
249	1C		G01-2924-04	TORSION COIL SPRING	
250	2C		G01-3065-04	EXTENSION SPRING	
251	3C		G01-3066-04	TORSION COIL SPRING	
252	3C		G01-3069-04	EXTENSION SPRING	
253	2C		G01-3080-04	TORSION COIL SPRING	
254	2C		G09-2038-04	FORMED WIRE	
257	3C		G16-1177-04	SHEET	
-			H10-4762-02	POLYSTYRENE FOAMED FIXTURE	
-			H25-0337-04	PROTECTION BAG (180X300X0.03)	
-			H25-1108-04	PROTECTION BAG (100X300X0.03)	
-			H25-1111-04	PROTECTION BAG (280X450X0.03)	
-			H30-0544-04	ADHESIVE DOUBLE-COATED TAPE	

Ref.No.	A d d	N e w	Parts No.	Description	Dest inati on
-		*	H54-2030-03	ITEM CARTON CASE	
263	2C		J21-9651-03	MOUNTING HARDWARE ASSY	
264	2C		J21-9699-04	MOUNTING HARDWARE	
265	1C		J21-9716-03	MOUNTING HARDWARE ASSY	
267	3C		J90-0999-04	GUIDE	
FPC2	1C		J84-0122-04	FLEXIBLE PRINTED WIRING BOARD	
269	3C		K24-3646-04	KNOB OPEN	
270	3C		K25-1215-03	KNOB EJECT	
271	3C		K25-1216-03	KNOB VOL	
272	3C		K25-1217-03	KNOB ATT	
273	3C		K25-1218-03	KNOB FM,AM	
274	3C		K25-1219-03	KNOB UP,DOWN	
275	3C		K25-1220-03	KNOB SRC	
276	3C		K25-1221-03	KNOB 1-6	
277	3C		K29-7017-03	KNOB LOCK	
281	1D		N99-1704-05	SCREW SET	
A	2C		N09-4400-05	MACHINE SCREW	
B	2C		N09-4401-05	MACHINE SCREW	
C	1C		N09-4427-05	TAPTITE SCREW	
D	2C		N09-4448-05	MACHINE SCREW	
E	3C		N09-4449-05	MACHINE SCREW	
F	2D		N19-2154-04	FLAT WASHER	
G	2C		N19-2155-04	FLAT WASHER	
H	2C		N19-2156-04	FLAT WASHER	
J	2C		N29-0522-05	RETAINING RING	
K	3C		N29-0523-05	RETAINING RING	
L	3C		N38-2025-46	PAN HEAD MACHIN SCREW	
M	3C		N80-2005-46	PAN HEAD TAPTITE SCREW	
N	3D		N09-4473-05	MACHINE SCREW	
P	1D		N83-3005-46	PAN HEAD TAPTITE SCREW	
Q	2C		N86-2004-45	BINDING HEAD TAPTITE SCREW	
285	1C		T90-0523-05	ANTENNA ADAPTOR	
PM1	1D		T42-1034-04	MOTOR ASSY	
ME1	1D		X92-4100-00	MECHANISM ASSY	
<b>SUB CIRCUIT UNIT (X16-1182-71)</b>					
J1	3C		E58-0903-05	RECTANGULAR RECEPTACLE	
FPC1	3C	*	J84-0121-12	FLEXIBLE PRINTED WIRING BOARD	
<b>SWITCH UNIT (X16-1282-70)</b>					
C1			CK73FB1C105K	CHIP C 1.0UF	K
C2			CK73GB0J105K	CHIP C 1.0UF	K
C3-5			CK73FB1C105K	CHIP C 1.0UF	K
C6,7			CK73GB1H103K	CHIP C 0.010UF	K
C8,9			CK73FB1A225K	CHIP C 2.2UF	K
C10			CK73EB0J106K	CHIP C 10UF	K
C11			CK73FB1A225K	CHIP C 2.2UF	K
C12			CK73GB1H103K	CHIP C 0.010UF	K
C19			CC73GCH1H101J	CHIP C 100PF	J
C20,21			CK73GB1H103K	CHIP C 0.010UF	K
C22			CK73FB1C105K	CHIP C 1.0UF	K
J1			E59-0835-05	RECTANGULAR PLUG	

⚠ indicates safety critical components.

# KDC-8090R

## PARTS LIST

\* New Parts

Parts without Parts No. are not supplied.

Les articles non mentionnes dans le Parts No. ne sont pas fournis.

Teile ohne Parts No. werden nicht geliefert.

**SWITCH UNIT(X16-1282-70)**  
**ELECTRIC UNIT(X25-8742-72)**

Ref.No.	A d d	N e w	Parts No.	Description	Dest inati on
L2-5			L40-1015-34	SMALL FIXED INDUCTOR	
L7			L92-0334-05	CHIP FERRITE	
L8			L92-0332-05	CHIP FERRITE	
X1			L78-0821-05	RESONATOR	
CP1			R90-0714-05	MULTI-COMP 10K X4	
CP2			R90-1014-05	MULTI-COMP 100 X4	
CP3			R90-0724-05	MULTI-COMP 1K X4	
CP4			R90-1022-05	MULTI-COMP 470 X2	
CP5			R90-0724-05	MULTI-COMP 1K X4	
CP6,7			R90-1014-05	MULTI-COMP 100 X4	
R1			R92-2018-05	CHIP R 560 J 1/2W	
R2			R92-1280-05	CHIP R 390 J 1/2W	
R3			RK73GB1J153J	CHIP R 15K J 1/16W	
R4,5			RK73GB1J274J	CHIP R 270K J 1/16W	
R6			RK73GB1J103J	CHIP R 10K J 1/16W	
R7			RK73EB2B101J	CHIP R 100 J 1/8W	
R8			RK73GB1J103J	CHIP R 10K J 1/16W	
R9			RK73GB1J102J	CHIP R 1.0K J 1/16W	
R11			RK73GB1J104J	CHIP R 100K J 1/16W	
R12			RK73GB1J102J	CHIP R 1.0K J 1/16W	
R13			RK73GB1J512J	CHIP R 5.1K J 1/16W	
R14			RK73GB1J102J	CHIP R 1.0K J 1/16W	
R15,16			RK73GB1J223J	CHIP R 22K J 1/16W	
R17			RK73FB2A100J	CHIP R 10 J 1/10W	
R18			RK73FB2A101J	CHIP R 100 J 1/10W	
R19			RK73GB1J102J	CHIP R 1.0K J 1/16W	
R20			RK73GB1J103J	CHIP R 10K J 1/16W	
R21			RK73GB1J225J	CHIP R 2.2M J 1/16W	
R22			RK73GB1J823J	CHIP R 82K J 1/16W	
R23			RK73GB1J103J	CHIP R 10K J 1/16W	
R24			RK73GB1J102J	CHIP R 1.0K J 1/16W	
R25			RK73FB2A220J	CHIP R 22 J 1/10W	
R26			RK73GB1J222J	CHIP R 2.2K J 1/16W	
R27			RK73GB1J104J	CHIP R 100K J 1/16W	
R29			RK73GB1J103J	CHIP R 10K J 1/16W	
S1-18			S70-0856-05	TACT SWITCH	
S19,20			S70-0857-05	TACT SWITCH	
S21			S70-0851-05	TACT SWITCH	
S22			S70-0864-05	TACT SWITCH	
D1,2			DA227	DIODE	
D3			MA3056-M	ZENER DIODE	
D4,5			MA3062WA	ZENER DIODE	
D6			DA204U	DIODE	
D7			MA3062WA	ZENER DIODE	
D8			DA204U	DIODE	
ED1			CN1976M	FLUORESCENT INDICATOR TUBE	
IC1			UPD703033GC059	MI-COM IC	
IC2			BA3830F	ANALOGUE IC	
IC3			RS-171	ANALOGUE IC	
Q1			DTA114YUA	DIGITAL TRANSISTOR	
Q2			DTA144EUA	DIGITAL TRANSISTOR	
Q3			DTA124EUA	DIGITAL TRANSISTOR	
Q4-8			DTC114EUA	DIGITAL TRANSISTOR	

Ref.No.	A d d	N e w	Parts No.	Description	Dest inati on
<b>ELECTRIC UNIT (X25-8742-72)</b>					
C1			C90-2822-05	ELECTRO 3900UF 16WV	
C2			CK73GB1H222K	CHIP C 2200PF K	
C3			C90-2866-05	ELECTRO 220UF 16WV	
C4			CK73GB1H103K	CHIP C 0.010UF K	
C5			C90-2594-05	ELECTRO 10UF 10WV	
C6			CE04CW0J101M	ELECTRO 100UF 6.3WV	
C7			CK73FB1C105K	CHIP C 1.0UF K	
C8			CE04CW1A221M	ELECTRO 220UF 10WV	
C9			CE04CW1A101M	ELECTRO 100UF 10WV	
C10			CK73GB1H103K	CHIP C 0.010UF K	
C11			C90-2962-05	ELECTRO 100UF 16WV	
C12			CK73GB1H103K	CHIP C 0.010UF K	
C13			C90-2962-05	ELECTRO 100UF 16WV	
C14			CK73FB1A225K	CHIP C 2.2UF K	
C15			C90-5375-05	ALMINIUM ELECTROLYTIC C.	
C17,18			CK73GB1H153K	CHIP C 0.015UF K	
C20			CK73GB1H103K	CHIP C 0.010UF K	
C21			CK73GB1E223K	CHIP C 0.022UF K	
C21			CK73GB1H223K	CHIP C 0.022UF K	
C22			C90-2608-05	ELECTRO 1.0UF 50WV	
C34			C90-2598-05	ELECTRO 3.3UF 25WV	
C35			CK73GB1C683K	CHIP C 0.068UF K	
C36			C90-2602-05	ELECTRO 0.10UF 50WV	
C37			CK73GB1H102K	CHIP C 1000PF K	
C38,39			CK73GB1H103K	CHIP C 0.010UF K	
C40			CE04CW0J470M	ELECTRO 47UF 6.3WV	
C41			CK73GB1H103K	CHIP C 0.010UF K	
C42			CC73GCH1H220J	CHIP C 22PF J	
C43			CC73GCH1H270J	CHIP C 27PF J	
C44,45			CK73GB0J105K	CHIP C 1.0UF K	
C46			CK73GB1H102K	CHIP C 1000PF K	
C48			CK73GB1H103K	CHIP C 0.010UF K	
C49-53			C90-2595-05	ELECTRO 4.7UF 16WV	
C54			CK73GB1H103K	CHIP C 0.010UF K	
C55			CK73FB1C105K	CHIP C 1.0UF K	
C61			CE04CW1A470M	ELECTRO 47UF 10WV	
C62			CK73GB1H103K	CHIP C 0.010UF K	
C63			C90-2610-05	ELECTRO 2.2UF 50WV	
C65-68			C90-2606-05	ELECTRO 0.47UF 50WV	
C69			CE04CW0J470M	ELECTRO 47UF 6.3WV	
C70			CK73GB1A474K	CHIP C 0.47UF K	
C71			CC73GCH1H151J	CHIP C 150PF J	
C72			CK73GB1E333K	CHIP C 0.033UF K	
C72			CK73GB1H333K	CHIP C 0.033UF K	
C73			CK73GB1H103K	CHIP C 0.010UF K	
C74,75			CK73GB1C104K	CHIP C 0.10UF K	
C74,75			CK73GB1H104K	CHIP C 0.10UF K	
C76,77			C90-2850-05	ELECTRO 10UF 10WV	
C93-96			C90-2597-05	ELECTRO 10UF 16WV	
C99-102			C90-2597-05	ELECTRO 10UF 16WV	
C111,112			CK73FB1H104K	CHIP C 0.10UF K	
C114			CE04CW1C220M	ELECTRO 22UF 16WV	
C115			C90-2608-05	ELECTRO 1.0UF 50WV	

⚠ indicates safety critical components.



## PARTS LIST

\* New Parts

Parts without Parts No. are not supplied.

Les articles non mentionnes dans le Parts No. ne sont pas fournis.

Teile ohne Parts No. werden nicht geliefert.

ELECTRIC UNIT(X25-8742-72)

Ref.No.	A d d	N e w	Parts No.	Description	Dest inati on
C116			C90-2606-05	ELECTRO 0.47UF 50WV	
C117-120			C90-5296-05	NP-ELECT 0.22UF 50WV	
C129			CK73GB1C104K	CHIP C 0.10UF K	
C129			CK73GB1H104K	CHIP C 0.10UF K	
C131			CK73GB1H103K	CHIP C 0.010UF K	
C133			CK73GB1H103K	CHIP C 0.010UF K	
C135			CK73GB1H103K	CHIP C 0.010UF K	
C137			CK73GB1H103K	CHIP C 0.010UF K	
C139			CK73GB1H103K	CHIP C 0.010UF K	
C141			CC73GCH1H331J	CHIP C 330PF J	
C142,143			C90-2594-05	ELECTRO 10UF 10WV	
C144			CK73GB1H103K	CHIP C 0.010UF K	
C145,146			CC73GCH1H100D	CHIP C 10PF D	
C147,148			CK73GB1A224K	CHIP C 0.22UF K	
C149			CK73GB1C104K	CHIP C 0.10UF K	
C150			CK73GB1H222K	CHIP C 2200PF K	
CN1			E40-3241-05	PIN ASSY	
CN2			E40-3237-05	PIN ASSY	
CN3			E40-3266-05	PIN ASSY	
CN4			E40-3261-05	PIN ASSY	
CN5			E40-9550-05	FLAT CABLE CONNECTOR	
CN6			E40-9557-05	FLAT CABLE CONNECTOR	
CN7			E40-5031-05	FLAT CABLE CONNECTOR	
J1			E58-0863-15	RECTANGULAR RECEPTACLE	
WH1			E30-4804-05	CORD WITH PLUG	
E1			J19-2826-05	HOLDER	
L1			L33-1170-05	CHOKO COIL ASSY	
L2			L33-1029-05	SMALL FIXED INDUCTOR	
L4			L40-4795-91	SMALL FIXED INDUCTOR(4.7UH,J)	
L5			L92-0075-05	CHIP FERRITE	
L6			L40-4795-91	SMALL FIXED INDUCTOR(4.7UH,J)	
L7			L33-1039-05	LINE FILTER COIL	
L9-14			L40-4795-91	SMALL FIXED INDUCTOR(4.7UH,J)	
X1			L78-0821-05	RESONATOR	
X2			L77-2738-05	CRYSTAL RESONATOR	
X3			L77-2002-05	CRYSTAL RESONATOR	
P	2D		N83-3005-46	PAN HEAD TAPTITE SCREW	
R	2D		N80-3008-46	PAN HEAD TAPTITE SCREW	
S	2D		N83-3012-46	PAN HEAD TAPTITE SCREW	
T	2D		N86-2606-46	BINDING HEAD TAPTITE SCREW	
R1			RK73FB2A223J	CHIP R 22K J 1/10W	
R2			RK73GB1J101J	CHIP R 100 J 1/16W	
R3			RK73GB1J223J	CHIP R 22K J 1/16W	
R4			RK73GB1J222J	CHIP R 2.2K J 1/16W	
R6			RK73GB1J153J	CHIP R 15K J 1/16W	
R7			R92-3032-05	CHIP R 4.3K D 1/10W	
R8			R92-3047-05	CHIP R 24K D 1/10W	
R9,10			RK73FB2A152J	CHIP R 1.5K J 1/10W	
R11			R92-2104-05	CHIP R 2.2 J 1W	
R12			RK73FB2A103J	CHIP R 10K J 1/10W	
R13			RK73EB2B102J	CHIP R 1.0K J 1/8W	
R14			RK73FB2A561J	CHIP R 560 J 1/10W	

Ref.No.	A d d	N e w	Parts No.	Description	Dest inati on
R15			RK73EB2B752J	CHIP R 7.5K J 1/8W	
R16			RK73GB1J222J	CHIP R 22K J 1/16W	
R17			RK73GB1J473J	CHIP R 47K J 1/16W	
R19			RK73EB2B103J	CHIP R 10K J 1/8W	
R20			RK73GB1J104J	CHIP R 100K J 1/16W	
R33			RK73FB2A472J	CHIP R 4.7K J 1/10W	
R37			RK73FB2A472J	CHIP R 4.7K J 1/10W	
R38			RD14DB2H102J	SMALL-RD 1.0K J 1/2W	
R39			RK73FB2A223J	CHIP R 22K J 1/10W	
R40			RD14DB2H102J	SMALL-RD 1.0K J 1/2W	
R41			RK73FB2A123J	CHIP R 12K J 1/10W	
R42			RK73GB1J123J	CHIP R 12K J 1/16W	
R43			RK73GB1J562J	CHIP R 5.6K J 1/16W	
R44			RK73GB1J223J	CHIP R 22K J 1/16W	
R45			RD14DB2H332J	SMALL-RD 3.3K J 1/2W	
R47			RK73GB1J183J	CHIP R 18K J 1/16W	
R48			RK73GB1J104J	CHIP R 100K J 1/16W	
R49			RK73GB1J103J	CHIP R 10K J 1/16W	
R50			RK73GB1J102J	CHIP R 1.0K J 1/16W	
R51			RK73GB1J104J	CHIP R 100K J 1/16W	
R53			RK73GB1J104J	CHIP R 100K J 1/16W	
R55			RK73GB1J104J	CHIP R 100K J 1/16W	
R60			RK73GB1J104J	CHIP R 100K J 1/16W	
R62			RK73GB1J104J	CHIP R 100K J 1/16W	
R66,67			RK73GB1J104J	CHIP R 100K J 1/16W	
R69-74			RK73GB1J102J	CHIP R 1.0K J 1/16W	
R75			RK73GB1J222J	CHIP R 2.2K J 1/16W	
R77			RK73GB1J102J	CHIP R 1.0K J 1/16W	
R78			RK73GB1J105J	CHIP R 1.0M J 1/16W	
R79			RK73GB1J222J	CHIP R 2.2K J 1/16W	
R80			RK73GB1J102J	CHIP R 1.0K J 1/16W	
R81			RK73GB1J222J	CHIP R 2.2K J 1/16W	
R82			RK73GB1J102J	CHIP R 1.0K J 1/16W	
R83			RK73GB1J222J	CHIP R 2.2K J 1/16W	
R84			RK73GB1J102J	CHIP R 1.0K J 1/16W	
R85			RK73GB1J104J	CHIP R 100K J 1/16W	
R86			RK73GB1J222J	CHIP R 2.2K J 1/16W	
R88			RK73GB1J222J	CHIP R 2.2K J 1/16W	
R91			RK73GB1J102J	CHIP R 1.0K J 1/16W	
R92,93			RK73GB1J104J	CHIP R 100K J 1/16W	
R94			RK73GB1J102J	CHIP R 1.0K J 1/16W	
R97			RK73GB1J104J	CHIP R 100K J 1/16W	
R98			RK73GB1J472J	CHIP R 4.7K J 1/16W	
R99			RK73GB1J104J	CHIP R 100K J 1/16W	
R100,101			RK73GB1J222J	CHIP R 2.2K J 1/16W	
R102			RK73GB1J102J	CHIP R 1.0K J 1/16W	
R104			RK73GB1J104J	CHIP R 100K J 1/16W	
R107			RK73GB1J104J	CHIP R 100K J 1/16W	
R108			RK73GB1J471J	CHIP R 470 J 1/16W	
R109			RK73GB1J104J	CHIP R 100K J 1/16W	
R110			RK73GB1J471J	CHIP R 470 J 1/16W	
R113,114			RK73GB1J102J	CHIP R 1.0K J 1/16W	
R115			RK73GB1J471J	CHIP R 470 J 1/16W	
R116			RK73GB1J472J	CHIP R 4.7K J 1/16W	
R117			RK73GB1J471J	CHIP R 470 J 1/16W	

⚠ indicates safety critical components.

## PARTS LIST

\* New Parts

Parts without Parts No. are not supplied.

Les articles non mentionnes dans le Parts No. ne sont pas fournis.

Teile ohne Parts No. werden nicht geliefert.

### ELECTRIC UNIT(X25-8742-72)

Ref.No.	A d d	N e w	Parts No.	Description	Dest inati on
R118			RK73GB1J472J	CHIP R 4.7K J 1/16W	
R119			RK73GB1J102J	CHIP R 1.0K J 1/16W	
R120			RK73GB1J103J	CHIP R 10K J 1/16W	
R121			RK73GB1J102J	CHIP R 1.0K J 1/16W	
R122			RK73GB1J103J	CHIP R 10K J 1/16W	
R124			RK73GB1J103J	CHIP R 10K J 1/16W	
R125			RK73GB1J473J	CHIP R 47K J 1/16W	
R126			RK73GB1J104J	CHIP R 100K J 1/16W	
R127			RK73GB1J222J	CHIP R 2.2K J 1/16W	
R130,131			RK73EB2B472J	CHIP R 4.7K J 1/8W	
R132-134			RK73EB2B101J	CHIP R 100 J 1/8W	
R135-137			RK73EB2B472J	CHIP R 4.7K J 1/8W	
R140			RK73GB1J473J	CHIP R 47K J 1/16W	
R141			RK73GB1J153J	CHIP R 15K J 1/16W	
R142			RK73GB1J102J	CHIP R 1.0K J 1/16W	
R143			RK73GB1J473J	CHIP R 47K J 1/16W	
R144			RK73GB1J333J	CHIP R 33K J 1/16W	
R145			RK73GB1J473J	CHIP R 47K J 1/16W	
R146			RK73GB1J821J	CHIP R 820 J 1/16W	
R147,148			RK73GB1J103J	CHIP R 10K J 1/16W	
R150			RK73GB1J472J	CHIP R 4.7K J 1/16W	
R151			RK73GB1J103J	CHIP R 10K J 1/16W	
R152			RK73GB1J472J	CHIP R 4.7K J 1/16W	
R153,154			RK73GB1J334J	CHIP R 330K J 1/16W	
R155,156			RK73EB2B100J	CHIP R 10 J 1/8W	
R157			RK73EB2B4R7J	CHIP R 4.7 J 1/8W	
R158			RK73GB1J102J	CHIP R 1.0K J 1/16W	
R161,162			RK73FB2A361J	CHIP R 360 J 1/10W	
R163,164			RK73FB2A223J	CHIP R 22K J 1/10W	
R169,170			RK73FB2A820J	CHIP R 82 J 1/10W	
R171,172			RK73FB2A361J	CHIP R 360 J 1/10W	
R173,174			RK73FB2A223J	CHIP R 22K J 1/10W	
R179,180			RK73FB2A820J	CHIP R 82 J 1/10W	
R200			RK73GB1J101J	CHIP R 100 J 1/16W	
R201			RK73GB1J103J	CHIP R 10K J 1/16W	
R202			RK73GB1J183J	CHIP R 18K J 1/16W	
R203			RK73GB1J473J	CHIP R 47K J 1/16W	
R204			RK73GB1J152J	CHIP R 1.5K J 1/16W	
R205-208			RK73GB1J223J	CHIP R 22K J 1/16W	
R211			RK73GB1J223J	CHIP R 22K J 1/16W	
R213			RK73GB1J223J	CHIP R 22K J 1/16W	
R214-216			RK73GB1J222J	CHIP R 2.2K J 1/16W	
R220,221			RK73GB1J104J	CHIP R 100K J 1/16W	
R223-225			RK73GB1J222J	CHIP R 2.2K J 1/16W	
R230			RK73GB1J472J	CHIP R 4.7K J 1/16W	
R231			RK73GB1J223J	CHIP R 22K J 1/16W	
R232			RK73EB2B472J	CHIP R 4.7K J 1/8W	
R233			RK73EB2B471J	CHIP R 470 J 1/8W	
R234,235			RK73EB2B102J	CHIP R 1.0K J 1/8W	
R236			RK73EB2B471J	CHIP R 470 J 1/8W	
R237			RK73EB2B102J	CHIP R 1.0K J 1/8W	
R239			RK73EB2B102J	CHIP R 1.0K J 1/8W	
R241			RK73GB1J102J	CHIP R 1.0K J 1/16W	
R242			RK73GB1J472J	CHIP R 4.7K J 1/16W	
W1-10			R92-1252-05	CHIP R 0 OHM	

Ref.No.	A d d	N e w	Parts No.	Description	Dest inati on
W15			R92-1252-05	CHIP R 0 OHM	
D1			RM10ZLF	DIODE	
D2			RB160L-40	DIODE	
D3			MA4056(N)-M	ZENER DIODE	
D4			MA4082(N)-L	ZENER DIODE	
D5			MA4100-L	ZENER DIODE	
D6			MA4051(N)-M	ZENER DIODE	
D7			MA4056-M	ZENER DIODE	
D8			MA4047-M	ZENER DIODE	
D11			1SR154-400	DIODE	
D12			AM01Z	DIODE	
D12			ERA15-01	DIODE	
D14			AM01Z	DIODE	
D14			ERA15-01	DIODE	
D15			1SS133	DIODE	
D16			MA4056(N)-M	ZENER DIODE	
D17			MA4062(N)-M	ZENER DIODE	
D18			1SS133	DIODE	
D19,20			DAP202U	DIODE	
D21			DA204K	DIODE	
D22-24			MA4062-L	ZENER DIODE	
D25,26			RD6.8M(B2)	ZENER DIODE	
D27,28			MA4068(N)-M	ZENER DIODE	
D29			MA4062-L	ZENER DIODE	
D30-32			1SS133	DIODE	
D33-36			1SR154-400	DIODE	
D38-41			1SR154-400	DIODE	
D44-50			DA204K	DIODE	
IC1			UPD703033GC051	MI-COM IC	
IC2			TDA7407	ANALOGUE IC	
IC3			M5237ML	IC(VOLTAGE REGULATOR)	
IC4			TA8273H	ANALOGUE IC	
IC7			TC74HC02AF	IC	
IC7			74VHC02SJ	MOS-IC	
IC8			NJM4565M-TE2	ANALOGUE IC	
IC14			TDA7479D	ANALOGUE IC	
IC15			LB1930M	ANALOGUE IC	
IC16			S-80837ANNP	MOS-IC	
Q1			2SB1548(P)	TRANSISTOR	
Q2			2SC4081	TRANSISTOR	
Q3			2SA1576A	TRANSISTOR	
Q4			2SB1548(P)	TRANSISTOR	
Q5			DTC144EUA	DIGITAL TRANSISTOR	
Q6,7			DTA124EUA	DIGITAL TRANSISTOR	
Q8			DTC124EUA	DIGITAL TRANSISTOR	
Q9			2SD2375	TRANSISTOR	
Q10			2SA1648-Z	TRANSISTOR	
Q11			2SC4081	TRANSISTOR	
Q12			DTC124EUA	DIGITAL TRANSISTOR	
Q13			DTA124EUA	DIGITAL TRANSISTOR	
Q14			DTA123JK	DIGITAL TRANSISTOR	
Q15			DTC144EUA	DIGITAL TRANSISTOR	
Q26			2SB1277(Q,R)	TRANSISTOR	
Q27			2SA1576A	TRANSISTOR	

⚠ indicates safety critical components.

## PARTS LIST

\* New Parts

Parts without Parts No. are not supplied.

Les articles non mentionnes dans le Parts No. ne sont pas fournis.

Teile ohne Parts No. werden nicht geliefert.

**ELECTRIC UNIT(X25-8742-72)**  
**CD PLAYER UNIT(X32-5030-00)**

Ref.No.	A d d	N e w	Parts No.	Description	Dest inati on
Q28			DTA124EUA	DIGITAL TRANSISTOR	
Q29			DTC114YUA	DIGITAL TRANSISTOR	
Q30,31			2SC4081	TRANSISTOR	
Q32,33			DTA124EUA	DIGITAL TRANSISTOR	
Q34			2SC4081	TRANSISTOR	
Q35			DTC124EUA	DIGITAL TRANSISTOR	
Q36			2SC4081	TRANSISTOR	
Q37-40			DTC143TUA	DIGITAL TRANSISTOR	
Q43			DTC124EUA	DIGITAL TRANSISTOR	
Q44			2SB1188(Q,R)	TRANSISTOR	
Q45			DTC124EUA	DIGITAL TRANSISTOR	
Q46			2SB1188(Q,R)	TRANSISTOR	
Q51			2SB1427	TRANSISTOR	
Q52			2SC4081	TRANSISTOR	
TH1			PTH9C42BD471Q	POSITIVE RESISTOR	
A1			W02-3272-05	ELECTRIC CIRCUIT MODULE	
F/E			X86-3342-70	TUNER UNIT	
<b>CD PLAYER UNIT (X32-5030-00)</b>					
C1,2			CK73FB1C105K	CHIP C 1.0UF K	
C3			CK73FB0J475K	CHIP C 4.7UF K	
C4			C92-0566-05	CHIP-TAN 10UF 6.3WV	
C5			CC73GCH1H150J	CHIP C 15PF J	
C6			CC73GCH1H020C	CHIP C 2.0PF C	
C7			CK73GB1C104K	CHIP C 0.10UF K	
C8			CK73FB1C105K	CHIP C 1.0UF K	
C10			CK73GB1H472K	CHIP C 4700PF K	
C11			CK73GB1H682K	CHIP C 6800PF K	
C12			CK73GB1H332K	CHIP C 3300PF K	
C13			CK73GB1C333K	CHIP C 0.033UF K	
C14			CK73GB1H472K	CHIP C 4700PF K	
C15			CK73GB1C473K	CHIP C 0.047UF K	
C16			CC73GCH1H151J	CHIP C 150PF J	
C17			CK73GB1H472K	CHIP C 4700PF K	
C18			CC73GCH1H221J	CHIP C 220PF J	
C19,20			CK73GB1C104K	CHIP C 0.10UF K	
C21			CK73FB0J475K	CHIP C 4.7UF K	
C23			CK73GB1H102K	CHIP C 1000PF K	
C24			CK73GB1E223K	CHIP C 0.022UF K	
C25			CK73GB1H153K	CHIP C 0.015UF K	
C26			CK73GB0J105K	CHIP C 1.0UF K	
C28			CK73GB0J105K	CHIP C 1.0UF K	
C29			CK73GB1C104K	CHIP C 0.10UF K	
C33-35			CK73GB1C104K	CHIP C 0.10UF K	
C41			CK73EB1C225K	CHIP C 2.2UF K	
C43			CK73GB1H153K	CHIP C 0.015UF K	
C45			CK73GB1H153K	CHIP C 0.015UF K	
C46			CK73GB1C473K	CHIP C 0.047UF K	
C51			CK73FB1C105K	CHIP C 1.0UF K	
C55			CK73GB1C104K	CHIP C 0.10UF K	
C63			C92-1359-05	CHIP-TAN 10UF 16WV	
C67,68			CK73GB0J105K	CHIP C 1.0UF K	
C71,72			CK73GB1H471K	CHIP C 470PF K	
C77,78			CC73GCH1H680J	CHIP C 68PF J	

Ref.No.	A d d	N e w	Parts No.	Description	Dest inati on
C79,80			CK73GB1H222K	CHIP C 2200PF K	
C85			CK73GB1C104K	CHIP C 0.10UF K	
C89			CK73GB1H222K	CHIP C 2200PF K	
CN1			E40-9536-05	FLAT CABLE CONNECTOR	
CN2			E40-9339-05	FLAT CABLE CONNECTOR	
CN2			E41-0129-05	FLAT CABLE CONNECTOR	
X1			L78-0572-05	RESONATOR (16.93MHZ)	
CP1-3			R90-1019-05	MULTI-COMP 100 X2	
R3			RK73GB1J272J	CHIP R 2.7K J 1/16W	
R5			RK73GB1J361J	CHIP R 360 J 1/16W	
R6			RK73GB1J272J	CHIP R 2.7K J 1/16W	
R8			RK73EB2B4R7J	CHIP R 4.7 J 1/8W	
R9			RK73EB2B100J	CHIP R 10 J 1/8W	
R10,11			RK73GB1J103J	CHIP R 10K J 1/16W	
R12			RK73GB1J912J	CHIP R 9.1K J 1/16W	
R15			RK73GB1J824J	CHIP R 820K J 1/16W	
R16			RK73GB1J223J	CHIP R 22K J 1/16W	
R17			RK73GB1J513J	CHIP R 51K J 1/16W	
R18			RK73GB1J392J	CHIP R 3.9K J 1/16W	
R19			RK73GB1J513J	CHIP R 51K J 1/16W	
R20			RK73GB1J104J	CHIP R 100K J 1/16W	
R21			RK73GB1J304J	CHIP R 300K J 1/16W	
R32			RK73GB1J104J	CHIP R 100K J 1/16W	
R34			RK73GB1J683J	CHIP R 68K J 1/16W	
R36			RK73GB1J151J	CHIP R 150 J 1/16W	
R37			RK73GB1J471J	CHIP R 470 J 1/16W	
R38			RK73GB1J224J	CHIP R 220K J 1/16W	
R44			RK73GB1J512J	CHIP R 5.1K J 1/16W	
R45			RK73GB1J103J	CHIP R 10K J 1/16W	
R46			RK73GB1J102J	CHIP R 1.0K J 1/16W	
R47			RK73GB1J103J	CHIP R 10K J 1/16W	
R49			RK73GB1J472J	CHIP R 4.7K J 1/16W	
R52			RK73GB1J104J	CHIP R 100K J 1/16W	
R54			RK73GB1J104J	CHIP R 100K J 1/16W	
R71			RK73GB1J103J	CHIP R 10K J 1/16W	
R72			RK73GB1J102J	CHIP R 1.0K J 1/16W	
R73			RK73GB1J473J	CHIP R 47K J 1/16W	
R75			RK73GB1J333J	CHIP R 33K J 1/16W	
R76			RK73GB1J622J	CHIP R 6.2K J 1/16W	
R77			RK73GB1J563J	CHIP R 56K J 1/16W	
R78			RK73GB1J243J	CHIP R 24K J 1/16W	
R81			RK73GB1J333J	CHIP R 33K J 1/16W	
R82			RK73GB1J123J	CHIP R 12K J 1/16W	
R83			RK73GB1J102J	CHIP R 1.0K J 1/16W	
R101,102			RK73GB1J332J	CHIP R 3.3K J 1/16W	
R103,104			RK73GB1J562J	CHIP R 5.6K J 1/16W	
R107,108			RK73FB2A331J	CHIP R 330 J 1/10W	
R117,118			RK73FB2A203J	CHIP R 20K J 1/10W	
R121,122			RK73FB2A203J	CHIP R 20K J 1/10W	
R125,126			RK73FB2A203J	CHIP R 20K J 1/10W	
R202			RK73GB1J104J	CHIP R 100K J 1/16W	
R213			RK73GB1J104J	CHIP R 100K J 1/16W	
R218			RK73GB1J473J	CHIP R 47K J 1/16W	

⚠ indicates safety critical components.

# KDC-8090R

## PARTS LIST

\* New Parts

Parts without Parts No. are not supplied.

Les articles non mentionnes dans le Parts No. ne sont pas fournis.

Teile ohne Parts No. werden nicht geliefert.

**CD PLAYER UNIT(X32-5030-00)**  
**CD MECHANISM ASSY(X92-4100-00)**

Ref.No.	A d d	N e w	Parts No.	Description	Dest inati on
R233			RK73GB1J622J	CHIP R 6.2K J 1/16W	
R234			RK73GB1J103J	CHIP R 10K J 1/16W	
W17			R92-2053-05	CHIP R 0 J 1/8W	
S1,2			S68-0838-05	PUSH SWITCH	
S3			S68-0859-05	PUSH SWITCH	
D1,2			DAN202U	DIODE	
D3			DA204U	DIODE	
D4			DAN202U	DIODE	
IC1			AN22000AA	ANALOGUE IC	
IC2			MN662773KF1	MOS-IC	
IC4			BA5917AFP	ANALOGUE IC	
IC5			TA78L05F	IC(VOLTAGE REGULATOR/ +5V)	
IC6			NJM4565MD	IC(OP AMP X2)	
Q1			MCH6101	TRANSISTOR	
Q2			DTC124EUA	DIGITAL TRANSISTOR	
Q3,4			2SA1362(Y)	TRANSISTOR	
Q5			DTC124EUA	DIGITAL TRANSISTOR	

### CD MECHANISM ASSY (X92-4100-00)

1	2A		A10-4482-01	CHASSIS	
2	1B		A10-4225-33	CHASSIS CALKING ASSY	
3	2B		A11-0915-43	SUB CHASSIS CALKING ASSY	
6	2A		D10-4306-04	ARM ASSY	
7	2A		D10-4305-04	ARM ASSY	
8	3A		D10-3087-44	ARM ASSY	
9	3B		D10-3092-03	SLIDER	
10	3B		D10-3093-04	SLIDER ASSY	
11	2B		D10-3095-04	SLIDER ASSY	
12	2B		D10-3096-04	SLIDER ASSY	
13	1A		D10-3099-24	SLIDER ASSY	
14	1A		D10-3100-04	SLIDER ASSY	
16	1B		D10-4004-04	LEVER ASSY	
17	1B		D10-4006-04	LEVER	
18	1A		D10-4007-04	LEVER	
19	2B		D10-4008-14	LEVER	
20	2A		D10-4009-23	ARM	
21	3A		D10-4010-04	LEVER	
22	3A		D10-4307-04	LEVER ASSY	
24	3B		D10-4050-04	ARM	
25	3A		D10-4038-23	ARM ASSY	
26	2A		D10-4123-24	LEVER ASSY	
27	3A		D13-1442-03	RACK (GEAR)	
29	3B		D13-1231-04	GEAR	
30	3A		D13-1240-04	GEAR	
31	3B		D13-1233-04	GEAR	
32	3B		D13-1234-14	GEAR ASSY	
33	3A		D13-1441-03	GEAR	
34	3B		D13-1232-04	GEAR	
35	3B		D13-1241-04	GEAR	
36	3A		D13-1242-04	GEAR	
37	1B		D13-1243-04	GEAR	
38	1B		D13-1244-04	GEAR	
39	1B		D13-1245-14	GEAR	
40	2A		D13-1246-04	GEAR	

Ref.No.	A d d	N e w	Parts No.	Description	Dest inati on
41	2B		D13-1247-04	GEAR	
43	2B		D13-1249-04	GEAR ASSY	
44	2B		D13-1341-04	GEAR ASSY (LEAD SCREW)	
45	1B		D14-0668-04	ROLLER	
46	2A		D14-0670-04	ROLLER	
47	3B		D14-0674-04	ROLLER	
49	3A		D21-2228-14	SHAFT	
50	1A		D21-2229-04	SHAFT	
51	1A		D23-0925-24	RETAINER	
52	2A		D32-0614-04	STOPPER	
53	1B		D39-0223-05	DAMPER (YELLOW)	
54	2B		D39-0224-05	DAMPER (BLACK)	
55	3B		F09-1246-04	SHEET	
58	3B		F09-1266-14	SHEET	
60	2A		G01-2770-04	EXTENSION SPRING	
61	3A		G01-2771-04	EXTENSION SPRING	
62	3A		G01-2772-24	EXTENSION SPRING	
63	3A		G01-2773-14	EXTENSION SPRING	
64	3A		G01-2774-34	EXTENSION SPRING	
65	1B		G01-2775-04	TORSION COIL SPRING	
66	1B		G01-2776-14	TORSION COIL SPRING	
67	3B		G01-2777-24	TORSION COIL SPRING	
69	2A		G01-2844-04	EXTENSION SPRING	
70	2A		G02-1231-04	FLAT SPRING	
71	2B		G02-1232-24	FLAT SPRING	
72	2A		G02-1241-24	FLAT SPRING	
75	2A		J11-0613-13	CLAMPER	
76	3A		J19-4678-13	HOLDER	
77	2B		J19-4679-24	HOLDER	
78	3B		J21-7684-13	MOUNTING HARDWARE	
79	2B		J21-7686-13	MOUNTING HARDWARE	
80	1B		J21-7690-03	MOUNTING HARDWARE	
82	3A		J84-0107-05	FLEXIBLE PRINTED WIRING BOARD	
83	1A		J90-0757-22	GUIDE	
A	2A		N09-4249-05	MACHINE SCREW (M1.7X2.5,LOCK)	
B	1B		N09-4172-05	TAPPING SCREW (2X3.5,CTITE)	
C	2B		N09-4202-05	STEPPED SCREW	
D	2A		N38-2020-46	PAN HEAD MACHIN SCREW	
E	3A		N09-4294-05	TAPTITE SCREW (BIND P TAPTIT)	
F	3B		N19-2023-04	FLAT WASHER	
G	2A		N19-2058-04	FLAT WASHER	
H	3A		N19-2093-04	FLAT WASHER	
J	2A		N39-2020-46	PAN HEAD MACHIN SCREW	
DM1	3B		T42-0764-04	DC MOTOR ASSY	
DM2	3B		T42-0763-04	DC MOTOR ASSY	
DPU1	2B		T25-0215-05	OPTICAL PICKUP HEAD	

⚠ indicates safety critical components.

## PARTS LIST

### CAPACITORS

CC 45 TH 1H 220 J  
 1 2 3 4 5 6

- 1 = Type ... ceramic, electrolytic, etc.
- 2 = Shape ... round, square, ect.
- 3 = Temp. coefficient
- 4 = Voltage rating
- 5 = Value
- 6 = Tolerance

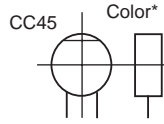

#### Capacitor value

- 010 = 1pF
- 100 = 10pF
- 101 = 100pF
- 102 = 1000pF = 0.001μF
- 103 = 0.01μF

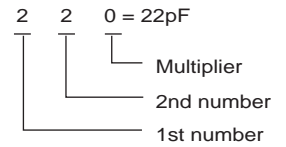

#### Temperature coefficient

1st Word	C	L	P	R	S	T	U
Color*	Black	Red	Orange	Yellow	Green	Blue	Violet
ppm/°C	0	-80	-150	-220	-330	-470	-750

2nd Word	G	H	J	K	L
ppm/°C	±30	±60	±120	±250	±500

Example : CC45TH = -470 ± 60ppm/°C

#### Tolerance (More than 10pF)

Code	C	D	G	J	K	M	X	Z	P	No code
(%)	±0.25	±0.5	±2	±5	±10	±20	+40 -40	+80 -20	+100 -0	More than 10μF Less than 4.7μF
										-10 ~ +50 -10 ~ +75

#### (Less than 10pF)

Gode	B	C	D	F	G
(pF)	±0.1	±0.25	±0.5	±1	±2

#### Voltage rating

2nd word	A	B	C	D	E	F	G	H	J	K	V
1st word											
0	1.0	1.25	1.6	2.0	2.5	3.15	4.0	5.0	6.3	8.0	-
1	10	12.5	16	20	25	31.5	40	50	63	80	35
2	100	125	160	200	250	315	400	500	630	800	-
3	1000	1250	1600	2000	2500	3150	4000	5000	6300	8000	-

#### Chip capacitors

(EX) C C 7 3 F S L 1 H 0 0 0 J  
 1 2 3 4 5 6 7

(Chip)(CH,RH<UJ,SL)

(EX) C K 7 3 F F 1 H 0 0 0 Z  
 1 2 3 4 5 6 7

(Chip)(B,F)

Refer to the table above.

- 1 = Type
- 2 = Shape
- 3 = Dimension
- 4 = Temp. coefficient
- 5 = Voltage rating
- 6 = Value
- 7 = Tolerance

#### Dimension (Chip capacitors)

Dimension code	L	W	T
Empty	5.6 ± 0.5	5.0 ± 0.5	Less than 2.0
A	4.5 ± 0.5	3.2 ± 0.4	Less than 2.0
B	4.5 ± 0.5	2.0 ± 0.3	Less than 2.0
C	4.5 ± 0.5	1.25 ± 0.2	Less than 1.25
D	3.2 ± 0.4	2.5 ± 0.3	Less than 1.5
E	3.0 ± 0.2	1.6 ± 0.2	Less than 1.25
F	2.0 ± 0.3	1.25 ± 0.2	Less than 1.25
G	1.6 ± 0.2	0.8 ± 0.2	Less than 1.0
H	1.0 ± 0.05	0.5 ± 0.05	0.5 ± 0.05

### RESISTORS

#### Chip resistor (Carbon)

(EX) R K 7 3 E B 2 B 0 0 0 J  
 1 2 3 4 5 6 7

(Chip)(B,F)

#### Carbon resistor (Nomal type)

(EX) R D 1 4 B B 2 C 0 0 0 J  
 1 2 3 4 5 6 7

- 1 = Type
- 2 = Shape
- 3 = Dimension
- 4 = Temp. coefficient
- 5 = Rating wattage
- 6 = Value
- 7 = Tolerance

#### Dimension

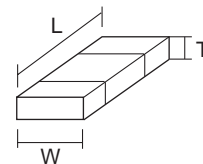

#### Dimension (Chip resistor)

Dimension code	L	W	T
E	3.2 ± 0.2	1.6 ± 0.2	1.0
F	2.0 ± 0.3	1.25 ± 0.2	1.0
G	1.6 ± 0.2	0.8 ± 0.2	0.5 ± 0.1
H	1.0 ± 0.05	0.5 ± 0.05	0.35 ± 0.05

#### Rating wattage

Code	Wattage	Code	Wattage	Code	Wattage
1J	1/16W	2C	1/16W	3A	1W
2A	1/10W	2E	1/4W	3D	2W
2B	1/8W	2H	1/2W		

# KDC-8090R

## SPECIFICATIONS

### FM Section

Frequency Range .....	87.5MHz~108.0MHz
(Frequency Step) .....	(50kHz)
Usable Sensitivity(S/N:26dB) .....	0.7 $\mu$ V/75 $\Omega$
Quieting Sensitivity(S/N:46dB) .....	1.6 $\mu$ V/75 $\Omega$
Frequency Response( $\pm$ 3.0dB) .....	30Hz~15kHz
S/N .....	65dB (MONO)
Selectivity .....	$\geq$ 80dB( $\pm$ 400kHz)
Stereo Separation .....	35dB(1kHz)

### MW Section

Frequency Range .....	531kHz~1611kHz
(Frequency Step) .....	(9kHz)
Usable Sensitivity(S/N:20dB) .....	25 $\mu$ V

### LW Section

Frequency Range .....	153kHz~281kHz
Usable Sensitivity(S/N:20dB) .....	45 $\mu$ V

### CD Section

Laser Diode .....	GaAlAs( $\lambda$ =780nm)
Digital Filter(D/A) .....	8 Times Over Sampling
D/A Converter .....	1Bit
Spindle Speed .....	500~200(CLV)
Wow & Flutter .....	Below Measurable Limit
Frequency Response .....	10~20kHz( $\pm$ 1dB)
Total Harmonic Distortion .....	0.01%(1kHz)
S/N Ratio .....	105dB(1kHz)
Dynamic Range .....	93dB
Channel Separation .....	96dB

### AMPLIFIER Section

Preout Level/Load .....	1800mV/10k $\Omega$ (CD/CD-CH)
Preout Impedance .....	$\leq$ 600 $\Omega$
Maximum Power .....	50W $\times$ 4
Power Output .....	30W $\times$ 4
(DIN45324, +B=14.4V)	

### TONE Section

Bass .....	100Hz $\pm$ 10dB
Middle .....	1kHz $\pm$ 10dB
Treble .....	10kHz $\pm$ 10dB

### General

Operating Voltage .....	14.4V
(11V~16V allowable)	
Current Consumption .....	10A
Installation Size (W) .....	182mm
(H) .....	53mm
(D) .....	162mm
Weight .....	1.9kg

---

KENWOOD follows a policy of continuous advancements in development. For this reason specifications may be changed without notice.

---